

LOGIC Wall Panel 16-Port

User Manual



Model ID: LOGICWALLPANEL16PORT

ILUMINARC®

Edition Notes

The LQGIC Wall Panel 16- Port User Manual includes a description, safety precautions, installation, programming, operation and maintenance instructions for the LQGIC Wall Panel 16- Port as of the release date of this edition.

Trademarks

CHAUVET, the Chauvet logo, LQGIC, and LQGIC Wall Panel 16- Port are registered trademarks or trademarks of Chauvet & Sons, LLC (d/b/a Chauvet and Chauvet Lighting) in the United States and other countries. Other company and product names and logos referred to herein may be trademarks of their respective companies.

Copyright Notice

The works of authorship contained in this manual, including, but not limited to, all designs, text, and images are owned by Chauvet.

© Copyright 2025 Chauvet & Sons, LLC. All rights reserved.

Electronically published by Chauvet in the United States of America.

Manual Use

Chauvet authorizes its customers to download and print this manual for professional information purposes only. Chauvet expressly prohibits the usage, copy, storage, distribution, modification, or printing of this manual or its content for any other purpose without written consent from Chauvet.

Document Printing

For best results, print this document in color, on letter size paper (8.5 x 11 in), double-sided. If using A4 paper (210 x 297 mm), configure the printer to scale the content accordingly.

Intended Audience

Any person installing, operating, and/or maintaining this product should completely read through the guide that shipped with the product, as well as this manual, before installing, operating, or maintaining this product.

Disclaimer

Chauvet believes that the information contained in this manual is accurate in all respects. However, Chauvet assumes no responsibility and specifically disclaims any and all liability to any party for any loss, damage or disruption caused by any errors or omissions in this document, whether such errors or omissions result from negligence, accident or any other cause. Chauvet reserves the right to revise the content of this document without any obligation to notify any person or company of such revision, however, Chauvet has no obligation to make, and does not commit to make, any such revisions.

Document Revision

Go to www.iluminarc.com for the latest version.

Revision	Date	Description
4	08/2025	Added 120V note in Setup section

TABLE OF CONTENTS

1. Before You Begin	1
What Is Included	1
Claims	1
Text Conventions	1
Symbols	1
Safety Notes.....	2
FCC Statement of Compliance	3
2. Introduction	4
Description	4
Product Overview	5
Front Overview.....	5
Front Panel Description	5
Side Overview	6
Product Dimensions	7
3. Setup	8
AC Power.....	8
Power Connection.....	8
Access Panel	8
Knockouts	8
Live Cabling	9
Grounded Cabling.....	11
Connection Diagram	12
Door Removal	12
Emergency Backup Power.....	12
AC Connections	12
LQIC Wall Controller	13
RJ12 Cable Wiring	13
Signal Connections	14
Control Personalities	14
DMX Linking.....	14
Remote Device Management.....	14
DMX/RDM Connection Diagram.....	14
Art-Net™ Connection	15
sACN Connection.....	15
Ethernet Connection Diagram	15
Terminating CAT6 Cables with RJ45 Connectors.....	15
LQIC Product Chaining	16
Mixing LQIC Products.....	17
LQIC POE X Linking.....	17
Mounting	18
Orientation.....	18
Rigging	18
Wall Mounting	18
Rack mounting.....	18
Panel Installation	18
Wall/Surface Mounting	21
Mounting Diagram	21
Knockouts	22
Logic Wall Panel Expansion Kit 8-Port.....	23
Installation Instructions.....	23

Step 1	23
Step 2	24
Step 3	25
Step 4	26
Step 5	27
Power Supply Overview	27
Step 5 Instructions	27
Step 6	29
Step 8	31
Finished	32
4. Operation	33
Control Panel Description	33
Programming	33
Password	33
Menu Map	33
RDM Chart	37
Home Screen	38
Control Protocol	38
Local	38
Output Status	38
Net Switch	38
Universe	38
Password Lock	38
Priority	39
History	39
Wall Con Zone	39
Local Information	39
System Reset	39
Match Net	39
Disconnecting Products from the LQGIC Wall Panel 16- Port	39
Linked Fixture	40
Linked LQGIC Product Menu Map	40
Individual LQGIC Product Configuration	41
Individual Control Personality	41
Starting Address	41
Network Settings	41
Factory Reset	41
Information	41
Renew	42
Control Personality (Global)	42
Power Selection	42
Breaking Signal	42
Control Channel Assignments and Values	43
FULL (10 Channels)	43
RGBW+D (5 Channels)	44
RGBW (4 Channels)	44
RGB (3 Channels)	44
TW (Tunable White: 2 Channels)	44
WHITE (1 Channel)	45
BLUE (1 Channel)	45
GREEN (1 Channel)	45
RED (1 Channel)	45
Static	45
Record	46
Recording	46
Display Menu Playback	46

Scene Brightness (via Display Menu).....	46
LOGIC Wall Controller Playback	46
Scene Brightness (via LOGIC Wall Controller).....	46
Scene Lock.....	46
Erase Recording	47
System Clock	47
Setting Clock	47
Schedule	47
Everyday.....	47
By date	48
By week	48
Enable Clock	48
Fade In and Fade Out.....	48
Web Server	49
Home.....	49
Status	50
Fixture List.....	50
Settings	51
Administrator Settings	52
Firmware Update	52
5. Maintenance.....	53
Product Maintenance	53
6. Technical Specifications	54
Contact Us	55
Warranty & Returns.....	55

1. Before You Begin

What Is Included

- LQGIC Wall Panel 16- Port
- Door keys (X2)
- LQGIC Wall Controller
- Quick Reference Guide

Claims

Carefully unpack the product immediately and check the container to make sure all the parts are in the package and are in good condition.



If the box or the contents (the product and included accessories) appear damaged from shipping, or show signs of mishandling, notify the carrier immediately, not Chauvet. Failure to report damage to the carrier immediately may invalidate a claim. In addition, keep the box and contents for inspection.

For other issues, such as missing components or parts, damage not related to shipping, or concealed damage, file a claim with Chauvet within 7 days of delivery.

Text Conventions

Convention	Meaning
1–512	A range of values
50/60	A set of values of which only one can be chosen
Settings	A menu option not to be modified
<ENTER>	A key to be pressed on the product's control panel

Symbols

Symbol	Meaning
	Critical installation, configuration, or operation information. Not following these instructions may make the product not work, cause damage to the product, or cause harm to the operator.
	Important installation or configuration information. The product may not function correctly if this information is not used.
	Useful information.



The term “DMX” used throughout this manual refers to the USITT DMX512-A digital data transmission protocol.

Safety Notes

These Safety Notes include important information about installation, use, and maintenance of the LQGIC Wall Panel 16- Port.



This product contains no user-serviceable parts. Any reference to servicing in this User Manual will only apply to properly trained, certified technicians. Do not open the housing or attempt any repairs.



All applicable local codes and regulations apply to proper installation of this product.

- **CAUTION:**

- This product's housing may be hot when operating. Mount this product in a location with adequate ventilation, at least 20 in (50 cm) from adjacent surfaces.
- When transferring the product from extreme temperature environments, (e.g., cold truck to warm humid ballroom) condensation may form on the internal electronics of the product. To avoid causing a failure, allow the product to fully acclimate to the surrounding environment before connecting it to power.
- Only qualified and competent persons should open this product for servicing. Turn off power before servicing!
- An external breaker and/or fuse branch-type overcurrent protection is required when running the product under a municipal electric environment.

- **ALWAYS:**

- Use a safety cable when mounting this product overhead.
- Connect this product to a grounded and protected circuit.



- **DO NOT:**

- Leave any flammable material within 0.3 m of this product while operating or connected to power.
- Connect this product to a dimmer or rheostat.
- Operate this product if the housing or cables appear damaged.
- Operate this product outdoors or in any location where dust, excessive heat, water, or humidity may affect it. (IP20)
- The maximum ambient temperature is 113 °F (45 °C). Do not operate this product at higher temperatures.
- The minimum ambient temperature is -4°F (-20°C). Do not operate the product at lower temperatures.
- To eliminate unnecessary wear and improve its lifespan, during periods of non-use completely disconnect the product from power via breaker or by unplugging it.
- In the event of a serious operating problem, stop using immediately.



If a Chauvet product requires service, contact Chauvet Technical Support.

FCC Statement of Compliance

This device complies with Part 15 Part B of the FCC rules. Operation is subject to the following two conditions:

1. This device may not cause harmful interference, and
2. This device must accept any interference received, including interference that may cause undesired operation.

This equipment has been tested and found to comply with the limits for a Class B digital device, pursuant to Part 15 of the FCC Rules. These limits are designed to provide reasonable protection against harmful interference in a residential installation. This equipment generates uses and can radiate radio frequency energy and, if not installed and used in accordance with the instructions, may cause harmful interference to radio communications. However, there is no guarantee that interference will not occur in a particular installation. If this equipment does cause harmful interference to radio or television reception, which can be determined by turning the equipment off and on, the user is encouraged to try to correct the interference by one or more of the following measures:

- Reorient or relocate the receiving antenna.
- Increase the separation between the equipment and receiver.
- Connect the equipment into an outlet on a circuit different from that to which the receiver is connected.
- Consult the dealer or an experienced radio/TV technician for help.

Any changes or modifications not expressly approved by the party responsible for compliance could void the user's authority to operate the equipment.

2. Introduction

Description

The LQIG Wall Panel 16- Port is designed to feed power and control remote fixtures using the POE latest standard IEEE 802.3 bt (power over Ethernet) and TCP/IP for control. It is equipped with 16 output ports and will support a maximum of 92.5 W/port. The Wall Panel can be expanded up to 32-ports using the 8-port expansion kits. The LQIG Wall Panel 16- Port includes one LOGIC Wall Con, which is a single gang wall controller that can recall up to 8 recorded scenes from the Wall Panel. Additional Wall Cons may be added to the system, up to 32 pcs on a single controller to have multiple control locations. The Wall Panel supports DMX, Art-Net, and sACN control protocols, and includes an integrated webserver to configure the date/time settings, which are used in the daily/calendar trigger. An integrated REST API is available for integration to use for custom control interfaces such as touchscreen control. The Wall Panel is supported by the Q-sys system.

Product Overview

Front Overview

Door closed

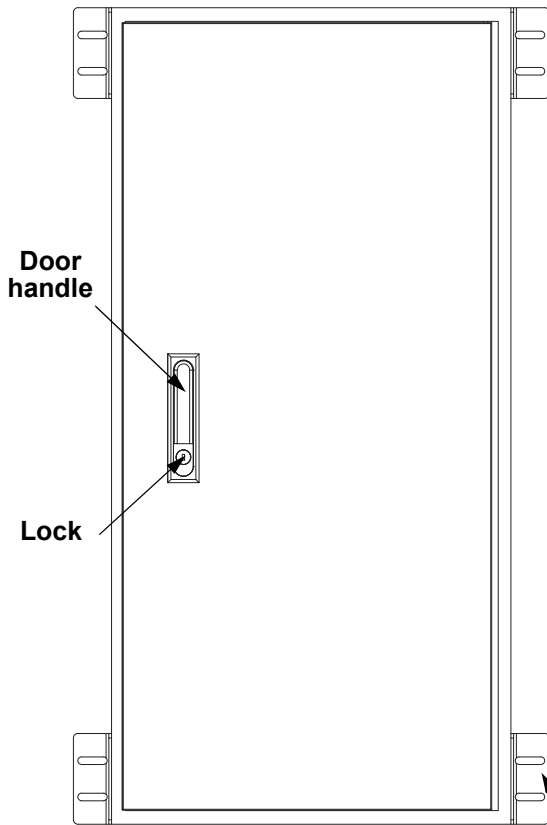

Door open

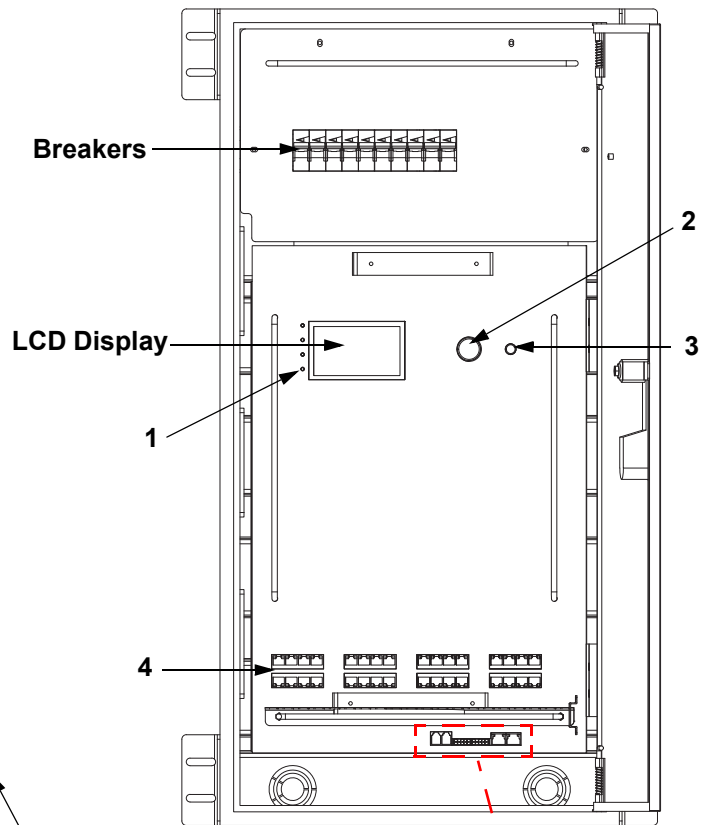

Rack/ mounting ears

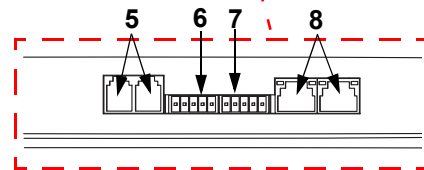

Front Panel Description

#	Name	Function
1	LED indicators	POWER: green, indicates power connection ETHERNET: yellow, indicates ethernet connection ACTIVITY (control): white, indicates controller signal ERROR/ALERT: disconnected fixtures cause this LED to light, among other alerts. Red, indicates an error (see Warning Messages in the menu)
2	MENU/ENTER	Rotate to navigate upwards or downwards through the menu list, and increase or decrease a selected numeric value. Push to enable the currently displayed menu option or set the currently selected value into the selected function.
3	<BACK> button	Exits the current menu or function
4	LOGIC FIXTURE OUTPUTS	IEEE 802.3bt POE RJ45 connector for output LQGIC products
5	WALL CON OUTPUT 1/2	RJ12 connectors for LQGIC Wall Controller
6	DMX IN	5-pin phoenix connector for DMX input
7	DMX THRU	5-pin phoenix connector for DMX output
8	NETWORK IN/THRU	RJ45 connectors for Ethernet input and through

Side Overview

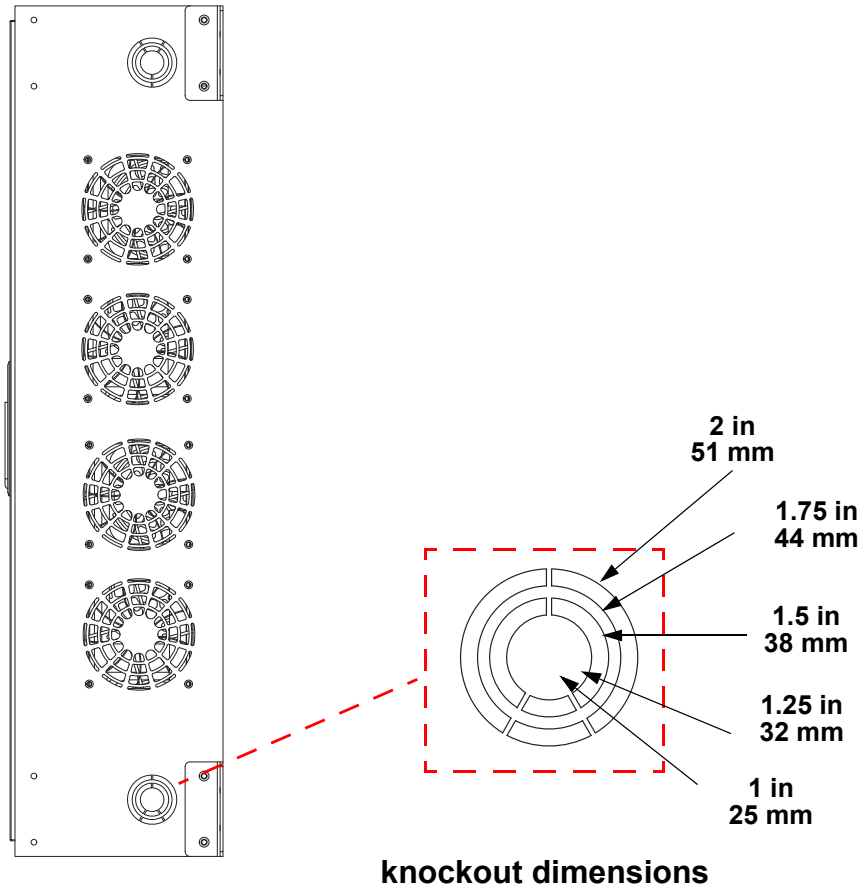

Product Dimensions

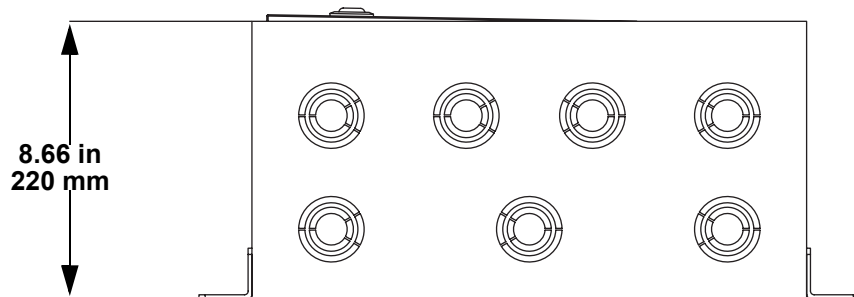
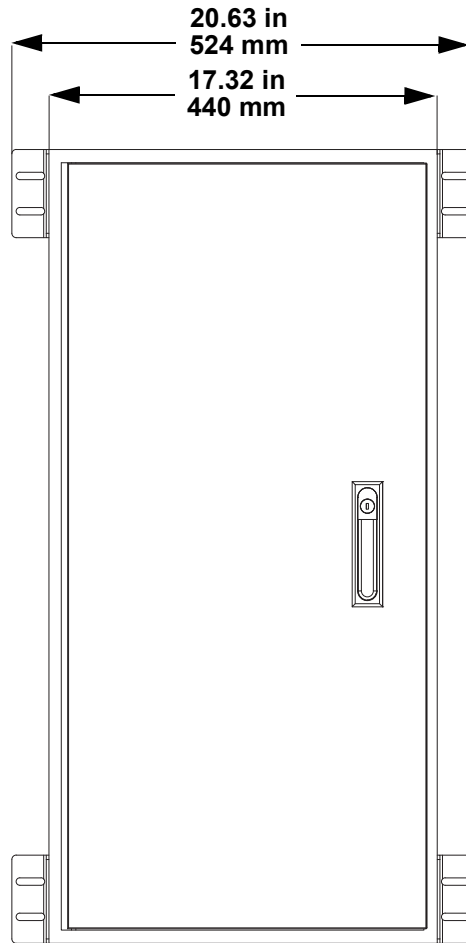
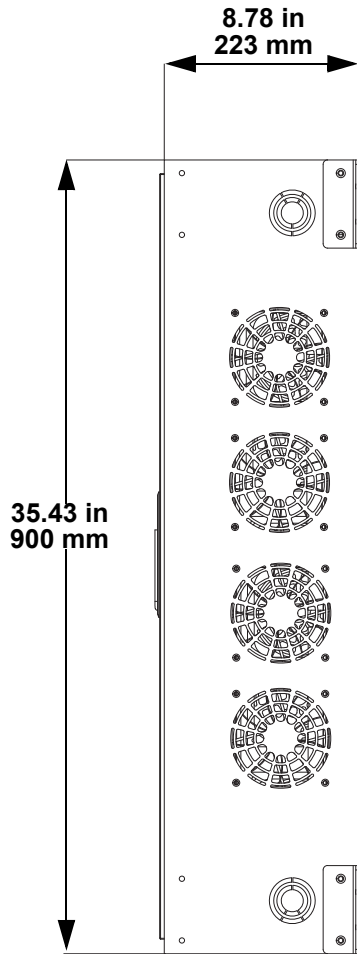

3. Setup

AC Power

The LQGIC Wall Panel 16- Port has an auto-ranging power supply and it can work with an input voltage range of 200 to 240 VAC, 50/60 Hz.

To determine the product's power requirements (circuit breaker, power outlet, and wiring), use the current value listed on the label affixed to the product's back panel, or refer to the [Technical Specifications](#). The listed current rating indicates the product's average current draw under normal conditions.



Always connect the product to a protected circuit (a circuit breaker or fuse). Make sure the product has an appropriate electrical ground to avoid the risk of electrocution or fire.



Never connect the product to a rheostat (variable resistor) or dimmer circuit, even if the rheostat or dimmer channel serves only as a 0 to 100% switch.

Power Connection

Before operating the LQGIC Wall Panel 16- Port, it is first necessary to setup a proper power connection. The following sections outline how to properly setup a power connection.



This should be done by a qualified/licensed electrician.

Access Panel

To properly establish a power connection, it is first necessary to remove the front access panel. Use a Philips head screw driver to remove the 4 no. 2 screws on the front of the access panel. For further information on removing the access panel, see the [Logic Wall Panel Expansion Kit 8-Port](#) section.

Knockouts

There are 7 potential knockouts from which users may select when feeding through an electrical conduit fitting. To prepare the product for an electrical conduit fitting, follow the instructions below:

1. There are 7 knockouts on the top of the product. Only use 1 of the 3 located at the back farthest from the door.

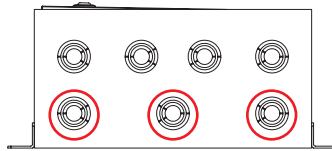

2. There are knockouts on either side of the product. Use only the 1 closest to the top and farthest from the door or the product for power connection.

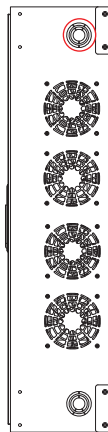

3. There are two knockouts on the back of the product. Use either for power connection.



Users should only use the knockouts specified for power connection. Other knockouts should be used for ethernet cabling. Using incorrect knockouts for power connection will leave high voltage cabling exposed in front of the access panel and may result in serious injury.

Live Cabling

To properly connect live cabling, do the following:

1. It is first necessary to crimp connectors onto the wire. To do this, strip the wire using an insulated wire crimper.



- **For wire input, crimp the connector onto wire before installing onto the terminal blocks and tighten the live screw firmly. Failure to do so may result in injury.**

2. Slide the insulated wire connector onto the stripped wire.

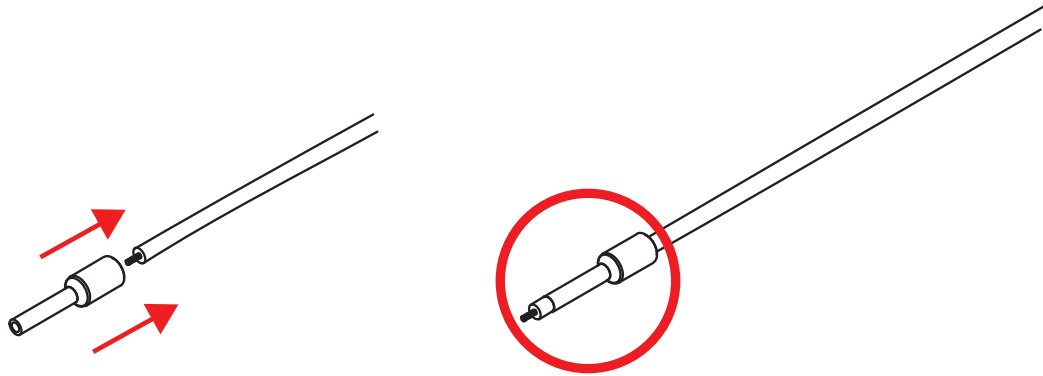

3. Crimp the connector onto the wire using an insulated wire crimper.



- **Use wire gromets/fittings and a screwdriver when to loosen or tighten the screws on the terminal blocks**

1. Remove the cover from the terminal block. To do this, simply press down and slide the cover off.

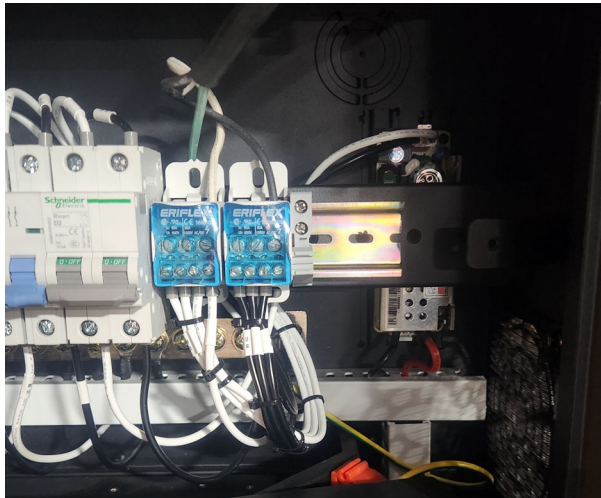

2. Use a flathead screwdriver to loosen the screw.

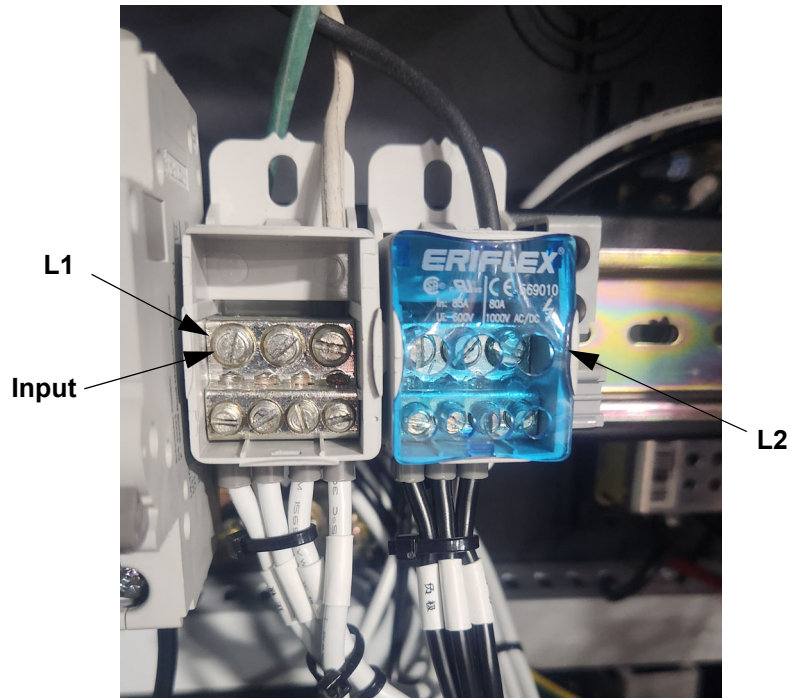

Cover has been removed from the L1 terminal block for illustrative purposes.

3. Once the screws are loose, connect the two live cables to each block and tighten the screw.



- The wires connecting to L1 terminal block are labeled “N” and are color coded white. This is because the product can operate at 120V. However, to reduce installation costs, Illuminarc recommends operating the product at 200-240VAC.
- Delta leg and neutral are suitable for this product. Single/3 phase double pole breaker power is also suitable.
- Always meter between L1 and L2 wires to ensure 200-240VAC power.
- Termination style: if using a solid wire, it can be directly wired to terminal block. If using stranded wire, use a ferrule.
- Input Wire Range: 4-12 AWG

Grounded Cabling

Run a ground from the main panel. Wire directly to the ground bus bar. To do this, follow the instructions below:

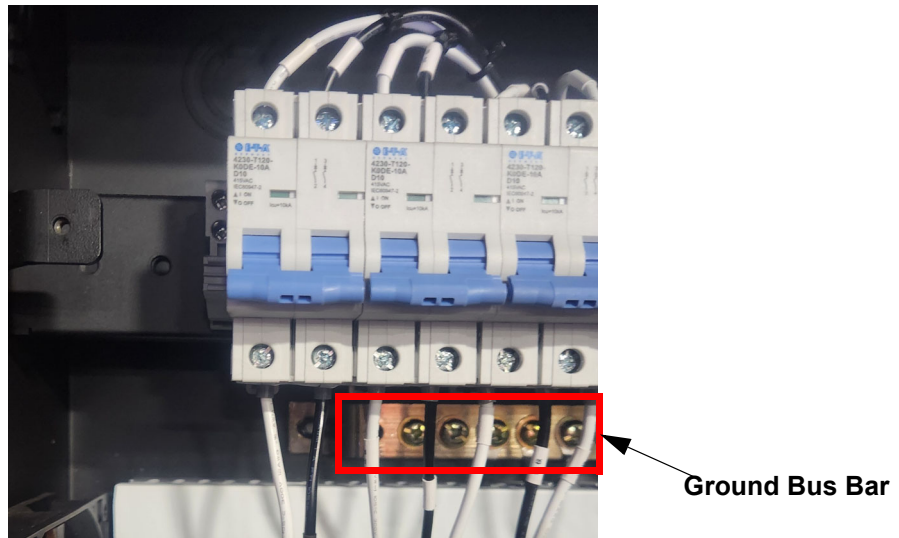

1. It is first necessary to crimp connectors onto the wire. To do this, strip the wire using an insulated wire crimper.



- **For wire input, crimp the connector onto wire before installing onto the bus bar and tighten the ground screw firmly. Failure to do so may result in injury.**

2. Slide the insulated wire connector/ferrule onto the stripped wire.

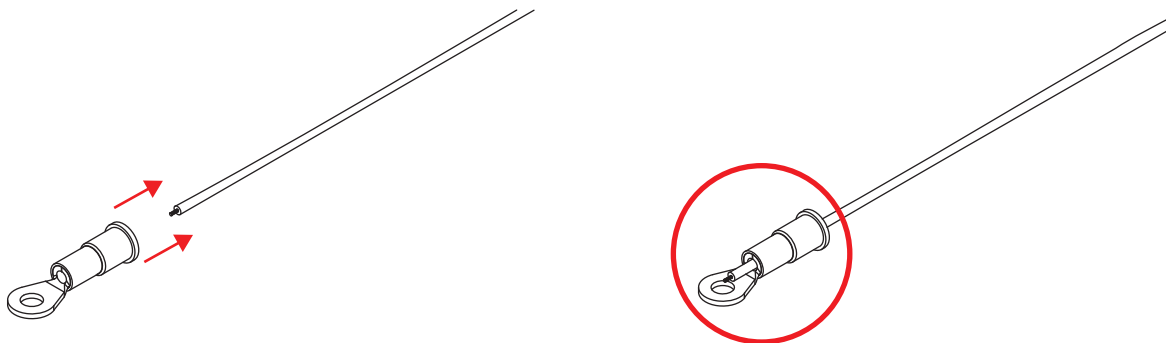

3. Crimp the connector onto the wire using an insulated wire crimper.



- **Use wire gromets/fitings and a screwdriver when to loosen or tighten the screws on the ground bus bar.**

Connection Diagram

See below for an illustration for of power connection and distribution:

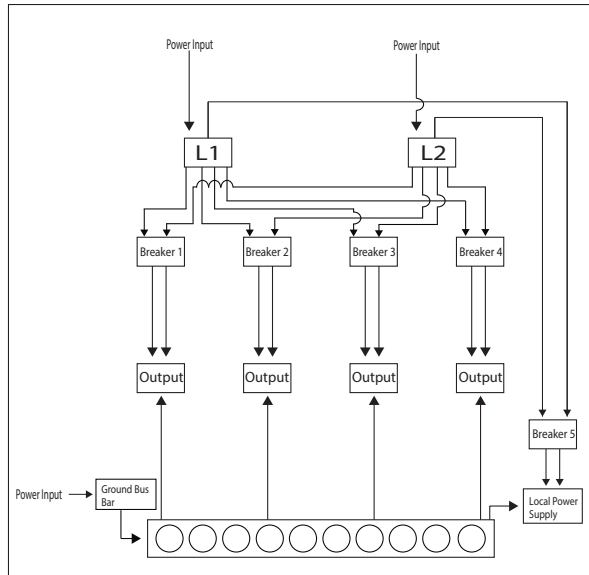

Door Removal

Users may opt to work with the product door attached or detached. The door is attached to the product by a spring-pin. To remove the door:

1. Open the door.
2. Locate the pin in the upper inside corner of the door.
3. Pull the pin upwards.
4. Remove the door from the product.

Emergency Backup Power

To keep the LQGIC system powered on and maintain the lighting in the case of an emergency, it is recommended to use a battery backup UPS (Uninterruptable Power Supply) between the LQGIC Wall Panel 16- Port and the mains power, as well as between each POE injector and the mains power.

This UPS can be one which is hardwired directly to the power cord included with the LQGIC Wall Panel 16- Port, or one with 120V Edison ports. See [AC Connections](#) for wiring information.

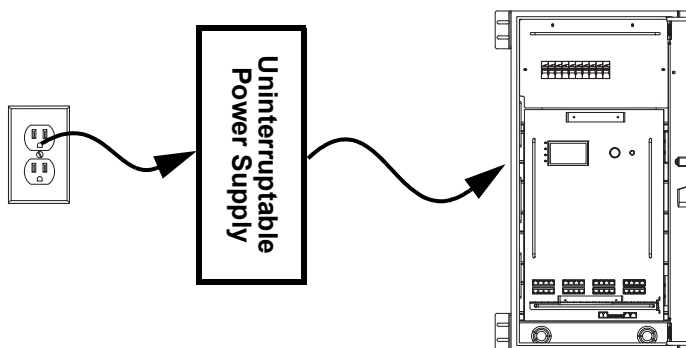

AC Connections

Connection	Wire (U.S.)	Wire (Europe)	Screw Color
AC Live	Black	Brown	Yellow or Brass
AC Neutral	White	Blue	Silver
AC Ground	Green/Yellow	Green/Yellow	Green

LQGC Wall Controller

Each LQGC Wall Panel 16- Port comes with a LQGC Wall Controller which can plug into the RJ12 connector on the back of the product.

- Buttons 1–8 trigger playback of the corresponding recorded scenes (see [Record](#)).
- After triggering a scene, press that button again and hold it for 6-10 seconds to lock the controls and prevent tampering. The selected button’s LED backlight will flash to indicate success. Press and hold the button again to unlock the controls. See [Scene Lock](#) for more information.
- Buttons 9 and 10 decrease and increase the brightness of the connected LQGC products.
- 5-bit DIP switches set the address of the LQGC Wall Controller with a binary number value. Each LQGC Wall Controller must have a unique address set by this DIP switch (from 0–31), or the LQGC Wall Panel 16- Port will be unable to respond to any LQGC Wall Controller. The order of addresses does not matter, only that they do not repeat.
- The LQGC Wall Panel 16- Port contains 2 output ports for the LQGC Wall Controller protocol, so up to 32 LQGC Wall Controller products can be chained to one LQGC Wall Panel 16- Port, allowing versatile and convenient control from multiple locations.
- The LQGC Wall Controller requires an RJ12 cable with flipped/reversed wiring. See [RJ12 Cable Wiring](#) for more information.

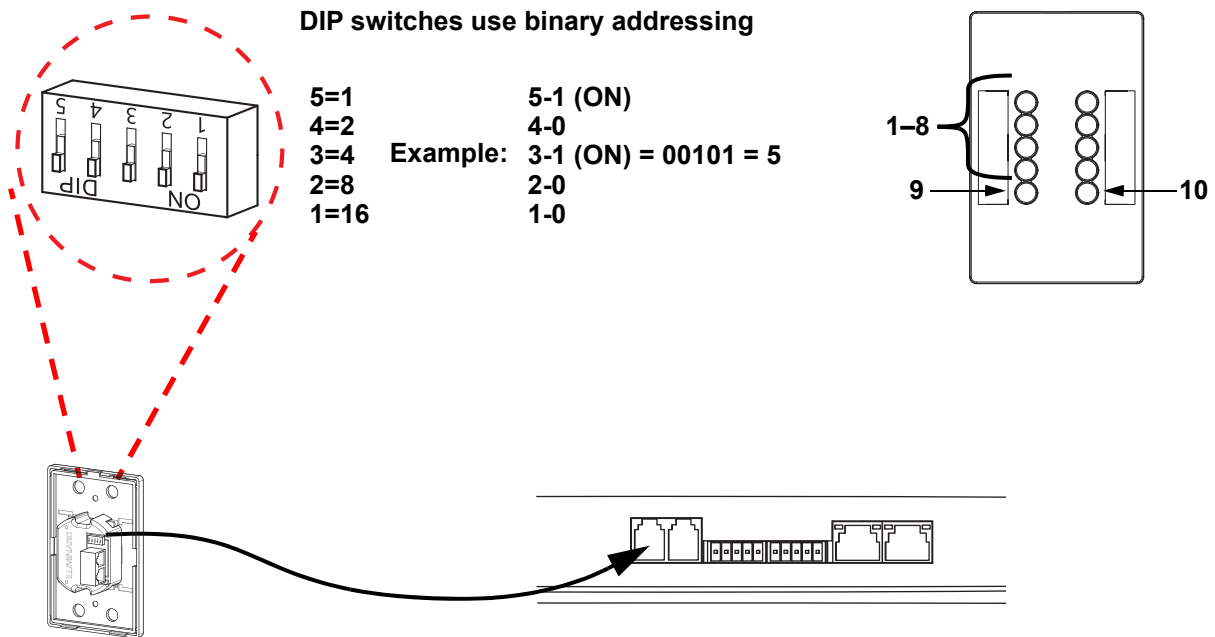

RJ12 Cable Wiring

The LQGC Wall Controller requires an RJ12 cable with flipped/reversed wiring. This means that pin 1 on one side connects to pin 6 on the other side, pin 2 connects to pin 5, pin 3 connects to pin 4, and so on. Using an RJ12 cable without flipped wiring may damage the product.

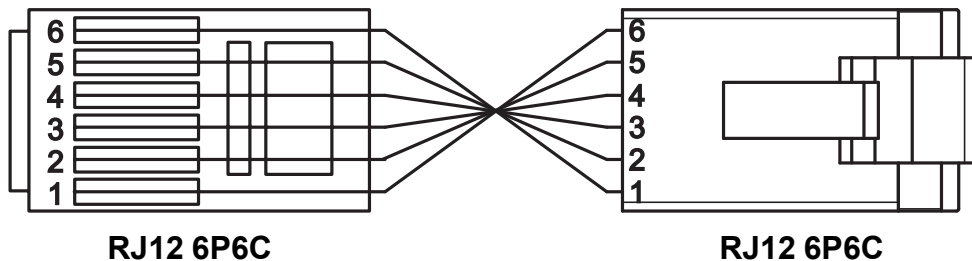

WARNING! The LQGC Wall Controller requires a flipped/reverse RJ12 cable! Incorrect wiring may damage the product!

Signal Connections

The LQGIC Wall Panel 16- Port can receive a DMX, RDM, Art-Net™, or sACN control signal. If using other compatible products with this product, each can be individually controlled with a single controller.

Control Personalities

The LQGIC Wall Panel 16- Port uses a 5-pin phoenix connection to receive DMX or RDM, or an ethernet connection to receive Art-Net™ or sACN, and a CAT6 ethernet connection to send control data to connected products for its 9 control personalities, ranging from 1 to 10 channels.

- Refer to the [Operation](#) chapter to learn how to configure the LQGIC Wall Panel 16- Port to work in these personalities.
- The [Control Channel Assignments and Values](#) section provides detailed information regarding the control personalities.



For more information about DMX standards or the DMX cables needed to link this product to a DMX controller, download the DMX Primer from the Chauvet website: www.iluminarc.com.

DMX Linking

The LQGIC Wall Panel 16- Port will work with a DMX controller using a 5-pin phoenix connector. For more information about DMX, read the DMX primer at: https://www.chauvetprofessional.com/wp-content/uploads/2016/06/DMX_Primer.pdf.

DMX Output

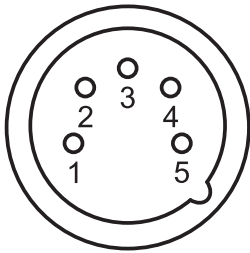

1. Ground
2. Data 1 -
3. Data 1 +
4. Not used
5. Not used

Signal Connector



Remote Device Management

Remote Device Management, or RDM, is a standard for allowing DMX-enabled devices to communicate bi-directionally along existing DMX cabling. Check the DMX controller's User Manual or with the manufacturer as not all DMX controllers have this capability. The LQGIC Wall Panel 16- Port supports RDM protocol that allows feedback to make changes to menu map options.

DMX/RDM Connection Diagram

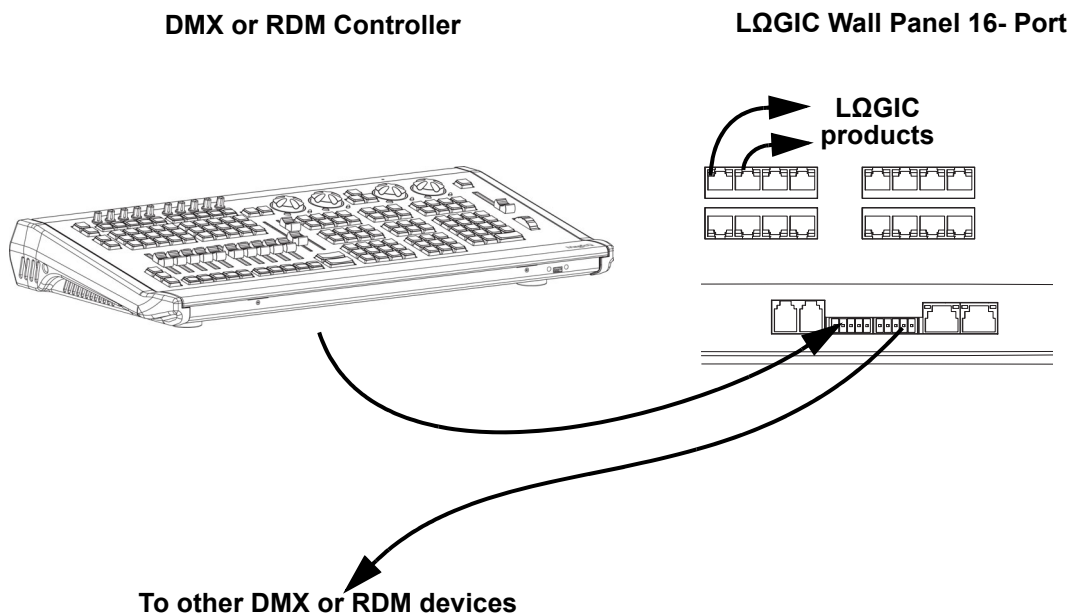

Art-Net™ Connection

Art-Net™ is an Ethernet protocol that uses UDP/IP which transfers a large amount of DMX512 data using an ethernet connection over a large network. An Art-Net™ protocol document is available from www.iluminarc.com.

Art-Net™ designed by and copyright Artistic Licence Holdings Ltd.

sACN Connection

Also known as ANSI E1.31, streaming ACN is an Ethernet protocol that uses the layering and formatting of Architecture for Control Networks to transport DMX512 data over IP or any other ACN compatible network.

Ethernet Connection Diagram

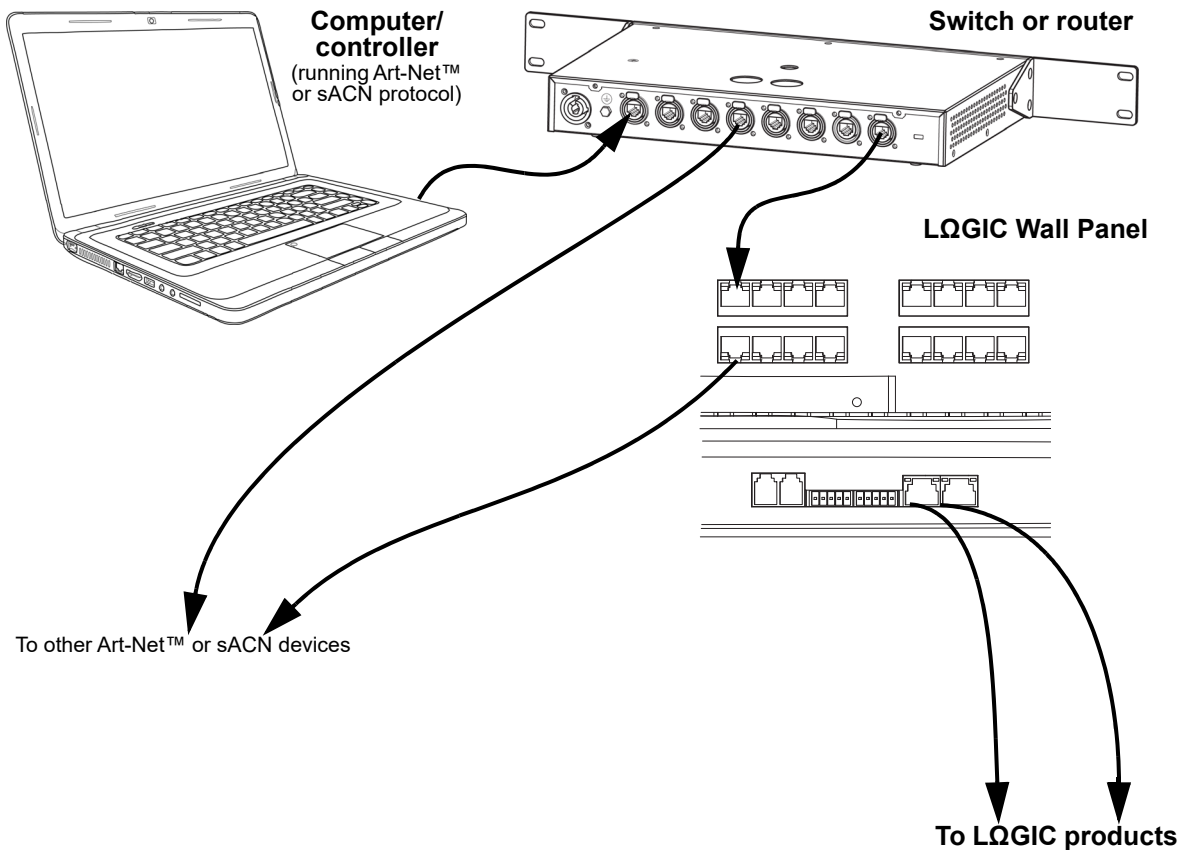

Terminating CAT6 Cables with RJ45 Connectors

The LQIC Wall Panel 16- Port communicates with Art-Net™ or sACN controllers and with connected LQIC products via RJ45 ethernet ports. In many applications, a cable with an attached connector will not fit through the required space, but will fit without the connector.

The LQIC system requires the use of T568B standard cable termination. Use the following table and diagram to ensure the RJ45 connectors are installed correctly to the CAT6 cables.

Pin	Wire Color	Pair	Diagram
1	White/Orange	2	<p>The diagram shows two RJ45 T568B connectors. The left connector has pins 1-8 labeled. The right connector has pins 1-8 labeled. Brackets indicate the following pairings: Pair 1 (pins 1, 2), Pair 2 (pins 3, 6), Pair 3 (pins 4, 5), and Pair 4 (pins 7, 8).</p>
2	Orange	2	
3	White/Green	3	
4	Blue	1	
5	White/Blue	1	
6	Green	3	
7	White/Brown	4	
8	Brown	4	

LQIGIC Product Chaining

The LQIGIC Wall Panel 16- Port powers and controls each connected LQIGIC product via a Power Over Ethernet (POE) connection. When linking LQIGIC products to the LQIGIC Wall Panel 16- Port, there is a set maximum number of each LQIGIC product which can be powered by a single port.

Product	Capacity per Port/POE	Power Consumption (per Product/Total)
LQIGIC AR111 Downlight M	3	27 W each / 81 W total
LQIGIC AR111 Downlight S	5	15.5 W each / 77.5 W total
LQIGIC MR16 Downlight S	8	8.3 W each / 66.4 W total*
LQIGIC Cove M	5	15 W each / 75 W total
LQIGIC Cove S	8	9.3 W each / 74.4 W total
LQIGIC Graze L	2	37.5 W each / 75 W total
LQIGIC Graze S	6	12.5 W each / 75 W total



*The LQIGIC MR16 Downlight S has additional power requirements which affect the maximum number of products that can be linked per port or POE injector. See [LQIGIC POE X Linking](#) for more information

Once that capacity has been reached, a POE injector must be incorporated into the chain to continue adding products. By continuing to add POE injectors as needed, a total of 40 LQIGIC products can be linked to each port of the LQIGIC Wall Panel 16- Port, regardless of the power consumption per product. Use only POE++, IEEE 802.3 bt, type 4 injectors (4PPOE).



When using 3rd party POE injectors with the LQIGIC system, the power consumption monitoring function in the LQIGIC Wall Panel 16- Port may become unavailable.

Refer to the [Technical Specifications](#) for the total maximum cable lengths possible.

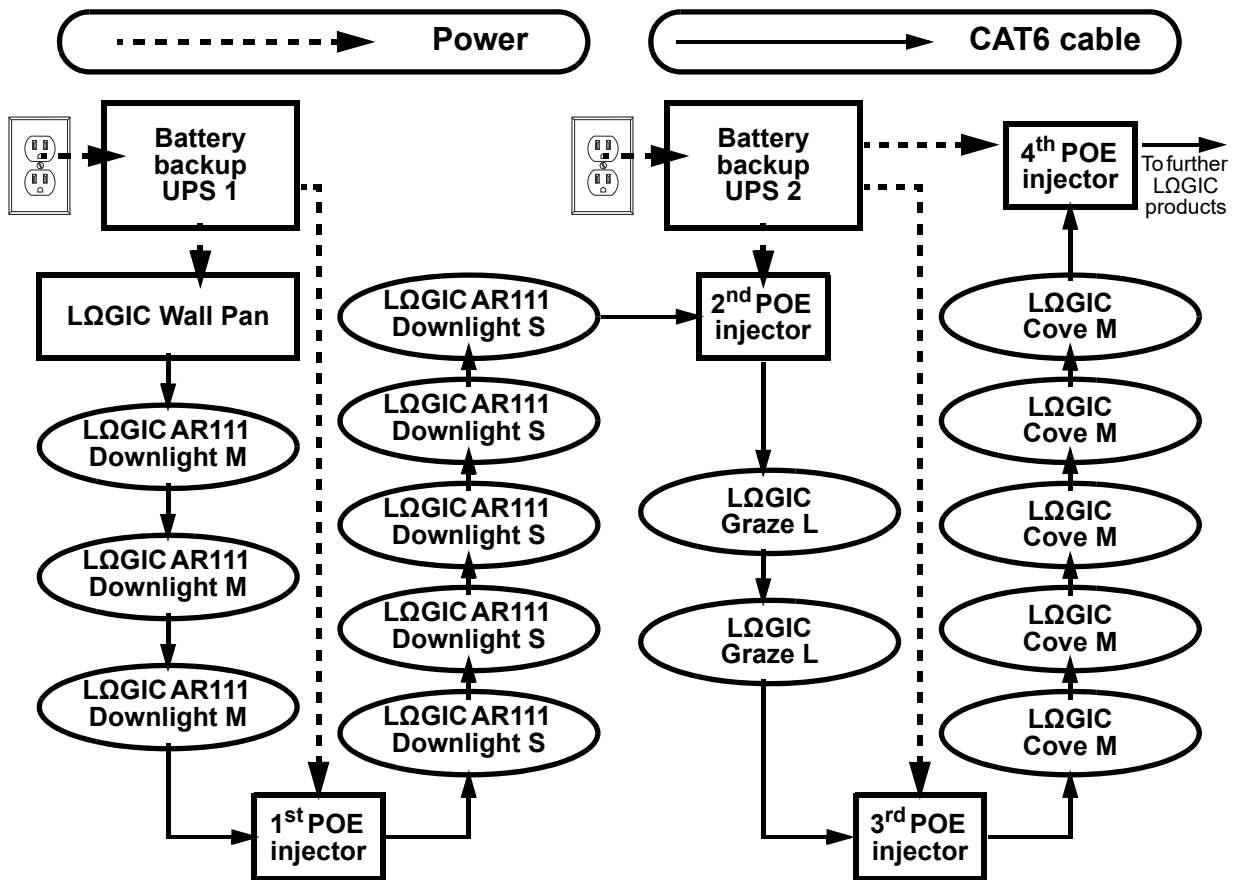

Mixing LQGC Products

While it is not recommended to mix different LQGC products in a section of chain powered by a single POE injector, it is possible to do so. For the best results when mixing multiple product types, keep the combined power consumption at or under 75 W before adding another POE injector to the chain.

LQGC POE X Linking

The LQGC MR16 Downlight S requires the use of a LQGC POE X between the first LQGC MR16 Downlight S in a chain and the LQGC Wall Panel 16- Port or any POE injector. The LQGC POE X steps down the POE voltage and performs a digital handshake which is necessary to allow the LQGC MR16 Downlight S to link correctly with the LQGC Wall Panel 16- Port.

The LQGC POE X has 3 ethernet ports:

- INPUT: inputs power (52V) and data signal from the LQGC Wall Panel 16- Port.
- THRU: for long-distance transmission. Outputs only the control signal from the LQGC Wall Panel 16- Port, no power. A POE injector must be used BEFORE the first LOGIC product in the chain to power it and further products connected to this port.
- OUTPUT: outputs power (48V) and data signal from the LQGC Wall Panel 16- Port. A POE injector and another LQGC POE X must be used after every 8 LQGC MR16 Downlight S products.

LQGC POE X

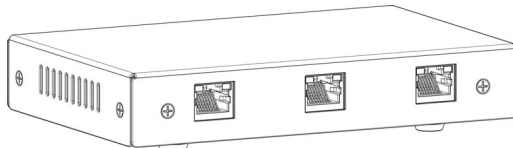

INPUT THRU OUTPUT

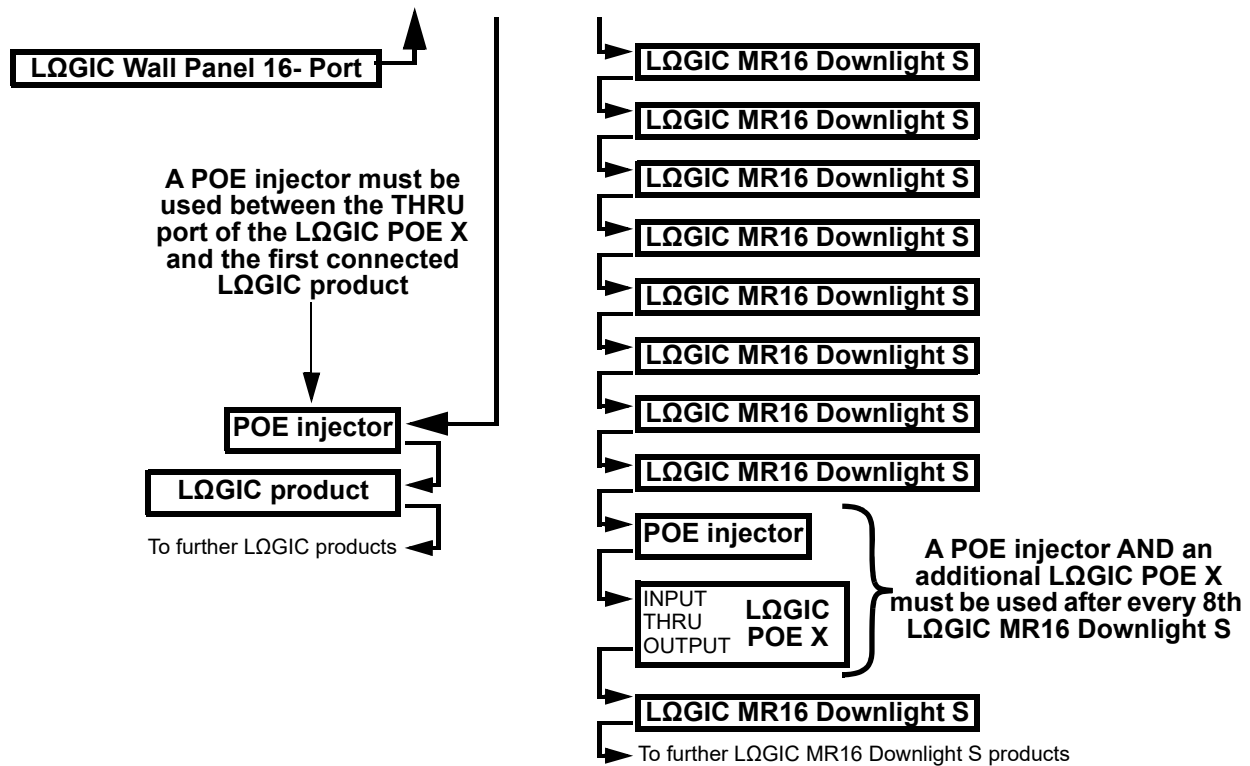

When using 3rd party POE injectors with the LQGC system, the power consumption monitoring function in the LQGC Wall Panel 16- Port may become unavailable.

Mounting

Before mounting the product, read and follow the safety recommendations indicated in the [Safety Notes](#).

Orientation

Always mount this product in a safe position, making sure there is adequate room for ventilation, configuration, and maintenance.

Rigging

Chauvet recommends using the following general guidelines when mounting this product.

- Before deciding on a location for the product, make sure there is easy access to the product for maintenance.
- Make sure the structure and attachment points can support the weight before hanging the product (See the [Technical Specifications](#)).

Wall Mounting

The LQGIC Wall Panel 16- Port has 4 rack ears on the top and bottom for hanging on a wall or securing to a surface. The LQGIC Wall Panel 16- Port fits on a standard 20U rack mount.

Rack mounting

To mount the product using a rack mount:

1. Identify the ideal point of installation in the room.
2. Ensure that the rack is stable before attempting to mount.
3. Mount the LQGIC Wall Panel 16- Port to the rack using the applicable hardware.

Panel Installation

To install the LQGIC Wall Panel 16- Port inside a rack mount:

1. If applicable, move the rack ears to the front of the product using a screwdriver.

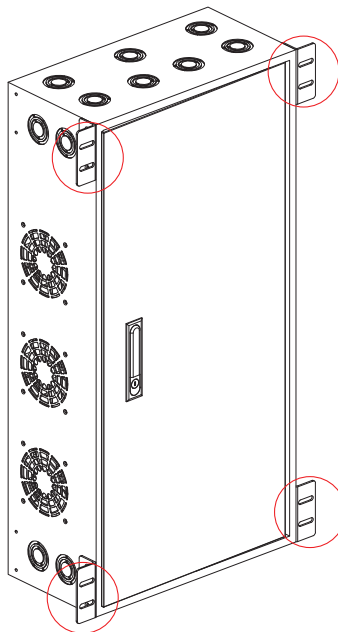

Rack ears must be front-facing for proper rack mount installation.

2. Remove necessary knockouts.



For further information on how to remove knockouts, see [Knockouts](#).

- Carefully insert the LQGIC Wall Panel 16- Port into the rack mount.

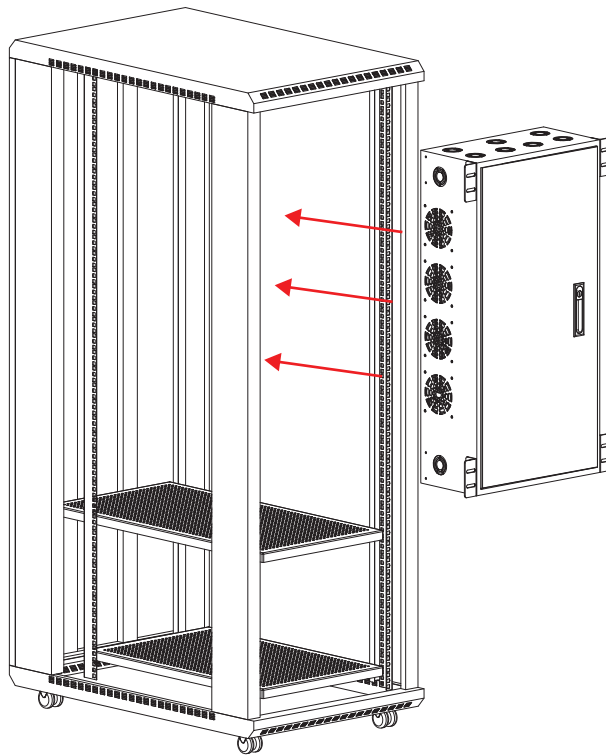

More than one person should participate in moving the panel onto the rack mount. Attempts to do so alone may result in damage to the product and/or serious injury.

- Once the LQGIC Wall Panel 16- Port is inside of the rack mount, ensure that the rack ears align correctly with the holes on the rack mount.

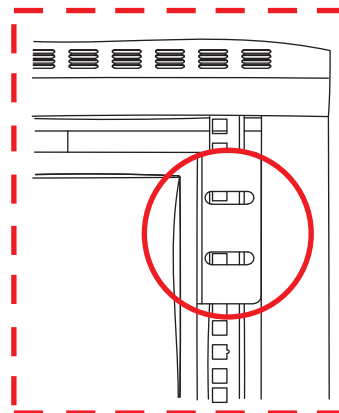
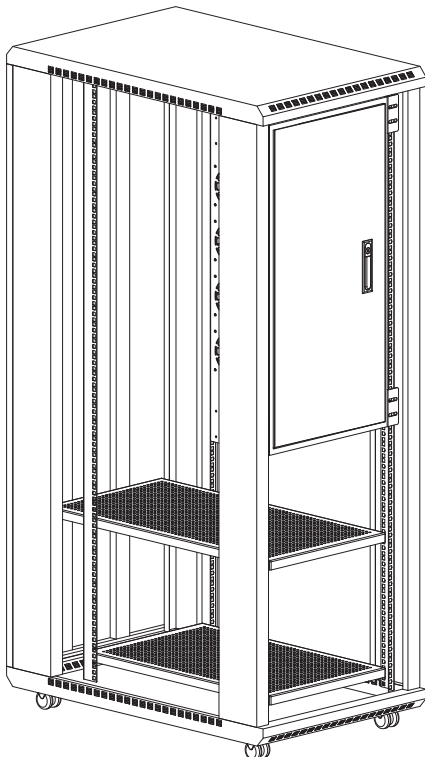

5. Holding the LQGIC Wall Panel 16- Port firmly in place, attach the product to the rack mount with 1/4 in, 3/8 in, or 5/16 in screws/bolts.

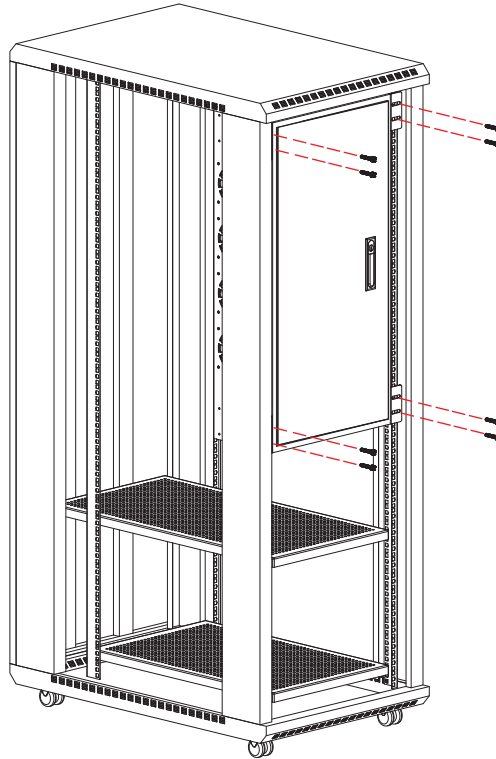

Ensure that the enclosure sits level and can support the weight of the product. Failure to do so may result in damage to the product and/or serious injury.

6. Ensure that all of the screws are tightly fastened to the rack mount.

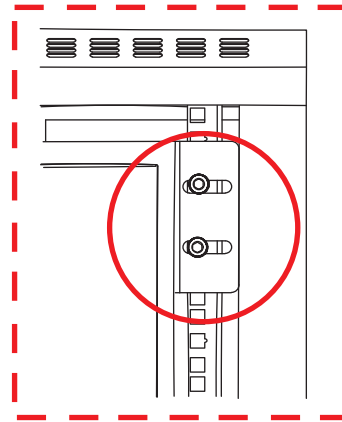
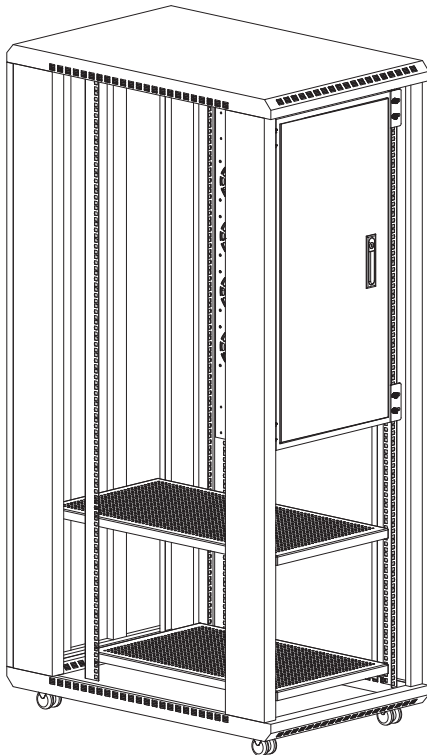

Wall/Surface Mounting

The LQGIC Wall Panel 16- Port may be directly attached to a wall/surface. To mount the product directly to a wall/surface:

i For maximum security, it is recommended to place the mounting hardware so they are at an equal height and the spacing between them is horizontal.

1. Position the 4 rack ear holes over the mounting hardware.
2. Shift the LQGIC Wall Panel 16- Port in one direction as far as it can go, so that it is fully secure.

i For maximum security, it is recommended to shift the LQGIC Wall Panel 16- Port downward on the mounting hardware. Doing otherwise places the product at risk of being dislodged and falling.

Mounting Diagram

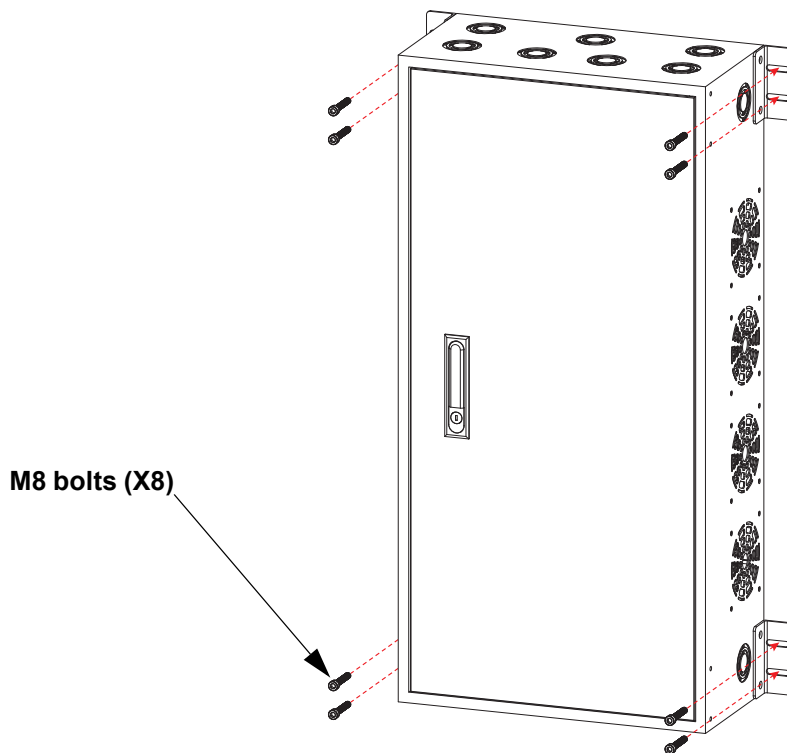

Knockouts

The LQGIC Wall Panel 16- Port has numerous knockouts. Knockouts are partially stamped removable openings in electrical enclosures and boxes. Knockouts are pre-designed and can be removed in order to allow electrical wiring to run through the enclosure.

To remove a knockout from the LQGIC Wall Panel 16- Port:

1. Identify which knockout to remove.

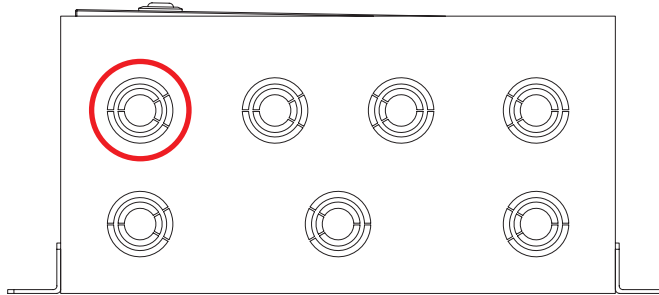

When deciding which knockout to remove, select the knockout that would allow the wires to remain straight with the least amount of bending.

2. Locate the knockout's attachment point.

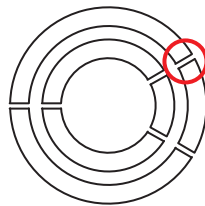

Each knockout has an attachment point -a small tab that has not been stamped and connects the knockout to the enclosure.

3. Place the tip of a flat-head screwdriver inside the edge of the knockout, on the opposite side of the attachment point.
4. Press the screwdriver or hit the end of the screwdriver to partially detach the knockout.



If the knockout still does not dislodge, additional pressure may be required. Use a hammer and hammer the screwdriver until the knockout is partially released.

5. Twist the partially detached knockout to completely remove it from the enclosure.
6. OPTIONAL: Once the knockout has been removed, install a strain-relief clamp to hold the wiring in place and prevent it from being damaged by the end of the enclosure.

Logic Wall Panel Expansion Kit 8-Port

The Logic Wall Panel Expansion Kit 8-Port allows users to add 8 output ports to the LQGIC Wall Panel 16-Port. A maximum of 2 Expansion Kits may be added to the LQGIC Wall Panel 16-Ports in a single box. For further instructions on the Logic Wall Panel Expansion Kit 8-Port, see the instructional manual at www.iluminarc.com.

Installation Instructions

Do the following to install the Logic Wall Panel Expand Kit8 in the LQGIC Wall Panel 16-Port:

Step 1

1. Unplug the LQGIC Wall Panel 16-Port from power.
2. Open the front panel of the LQGIC Wall Panel 16-Port.
3. Use a #2 Phillips-head screwdriver and a 2.5 mm hex wrench to remove the indicated screws.

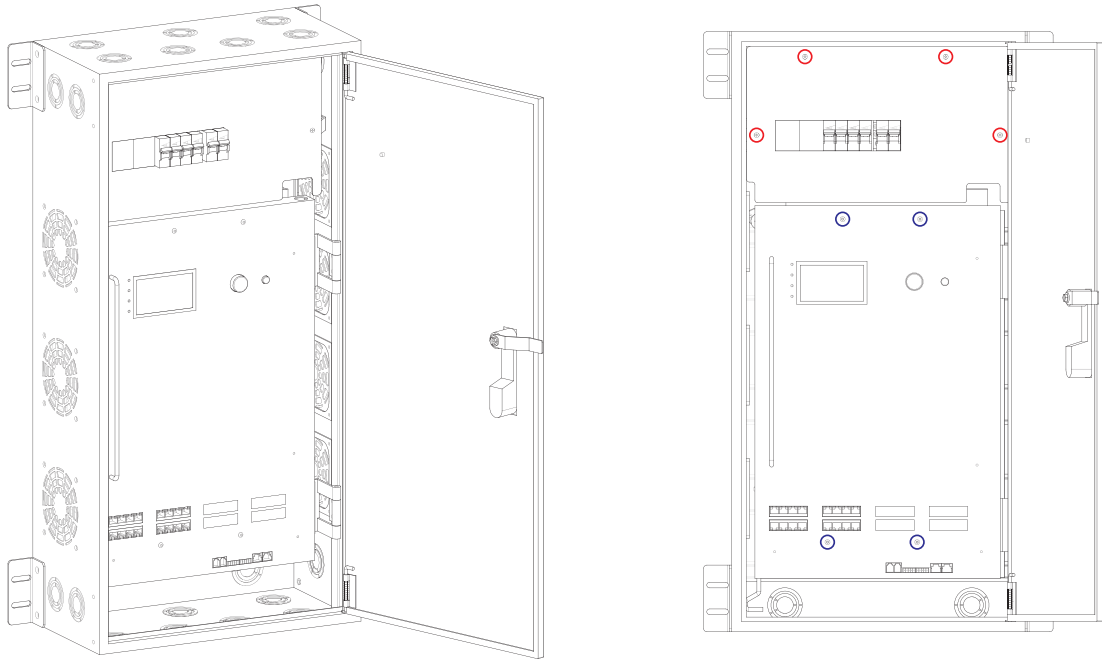

Step 2

1. Carefully remove the breaker cover and open the service access panel.

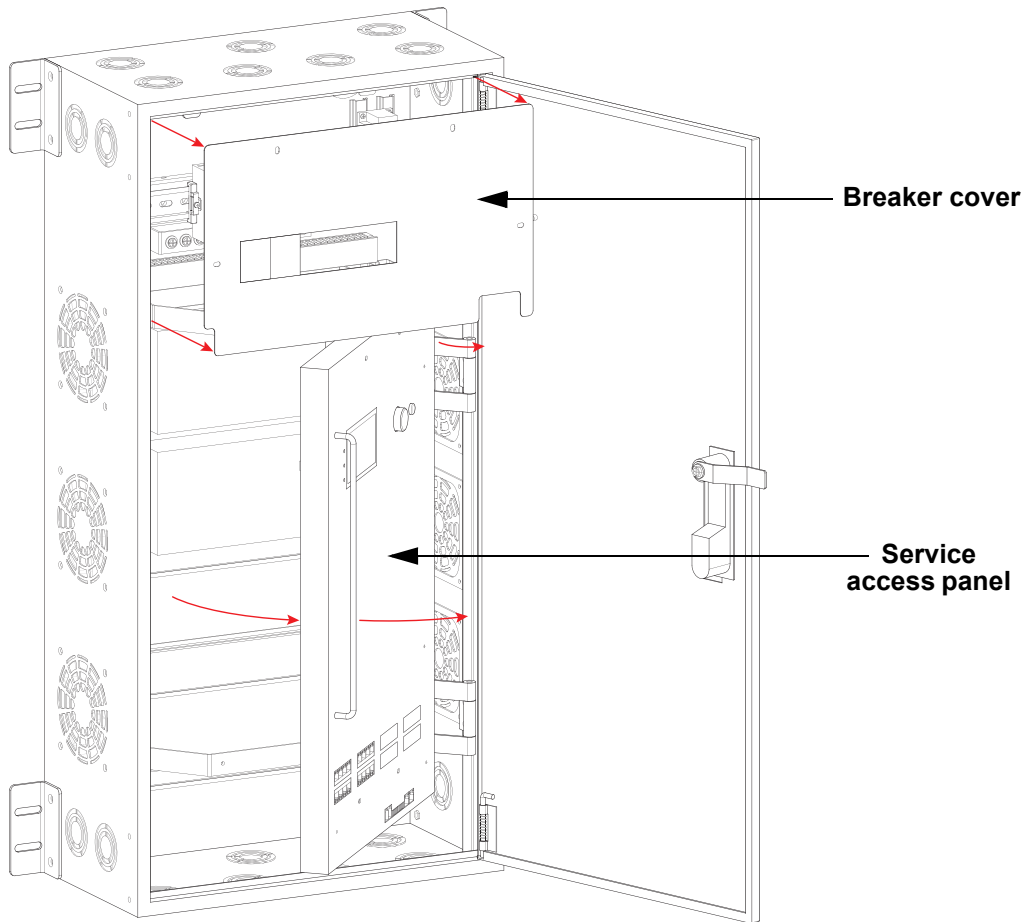

2. Remove the applicable plugs from the breaker cover and service access panel.

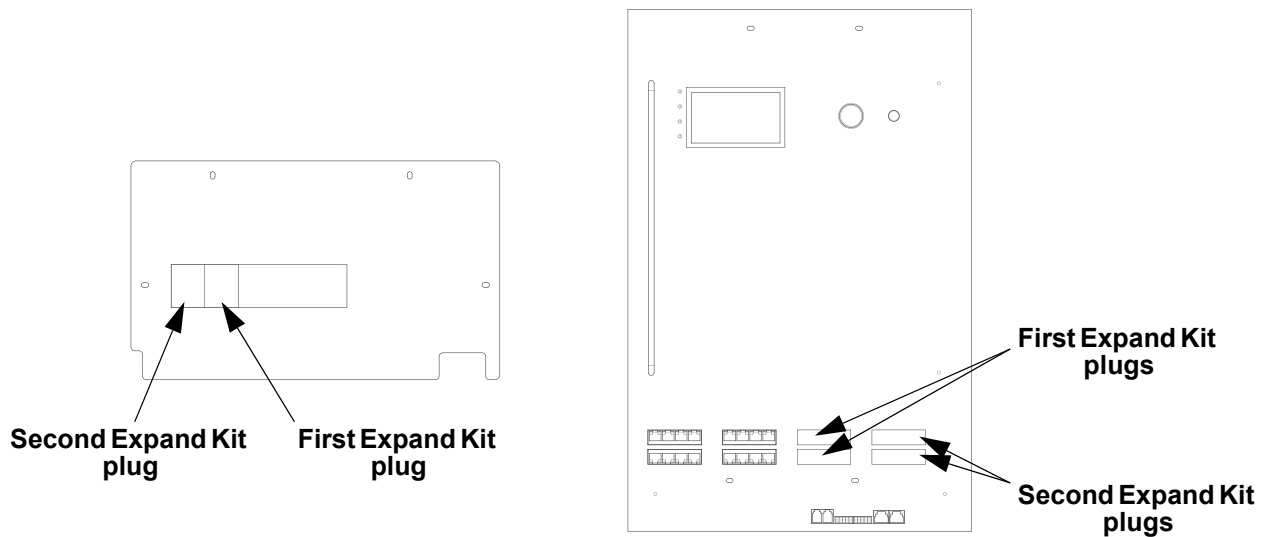

Do not remove the plugs for an Expand Kit unless installing an Expand Kit in that slot.

Step 3

1. Use a #2 Phillips-head screwdriver to install the 8-port POE output board with the 6 screws.

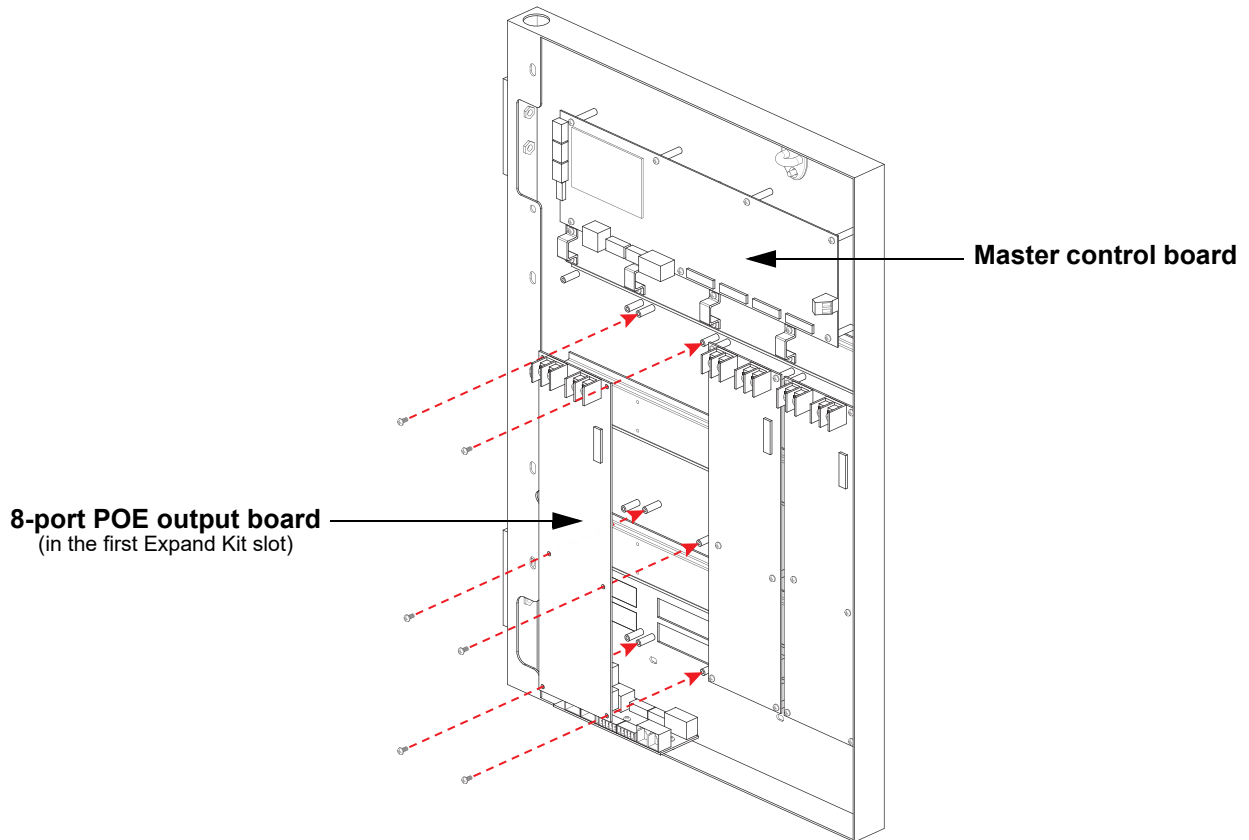

2. Cut the zip tie indicated below, being sure not to damage the wires.
3. Use a #2 Phillips-head screwdriver to install the output board power wires.
 - Connect the black wires to the terminals marked “-”.
 - Connect the red wires to the terminals marked “+”.

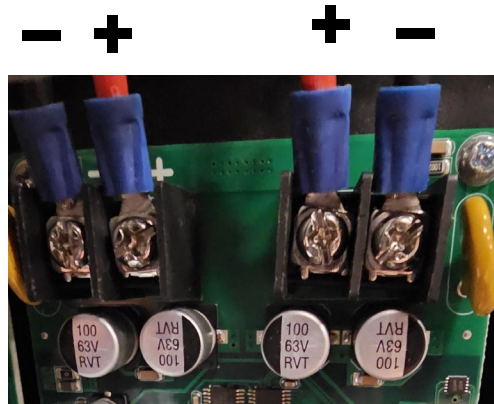
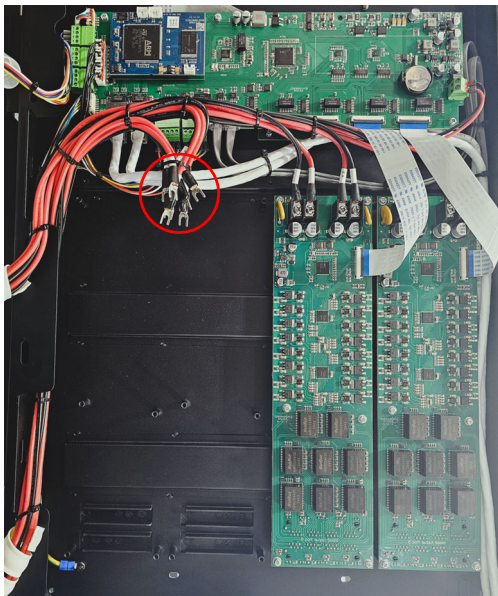

4. Secure the wires for an unused expansion slot with a zip tie or other fastener so they do not contact any electronics.

Step 4

1. Identify the ribbon cable port on the master control board which corresponds with the Expand Kit slot.
2. Open the applicable ribbon cable ports on the 8-port POE output board and on the master control board.

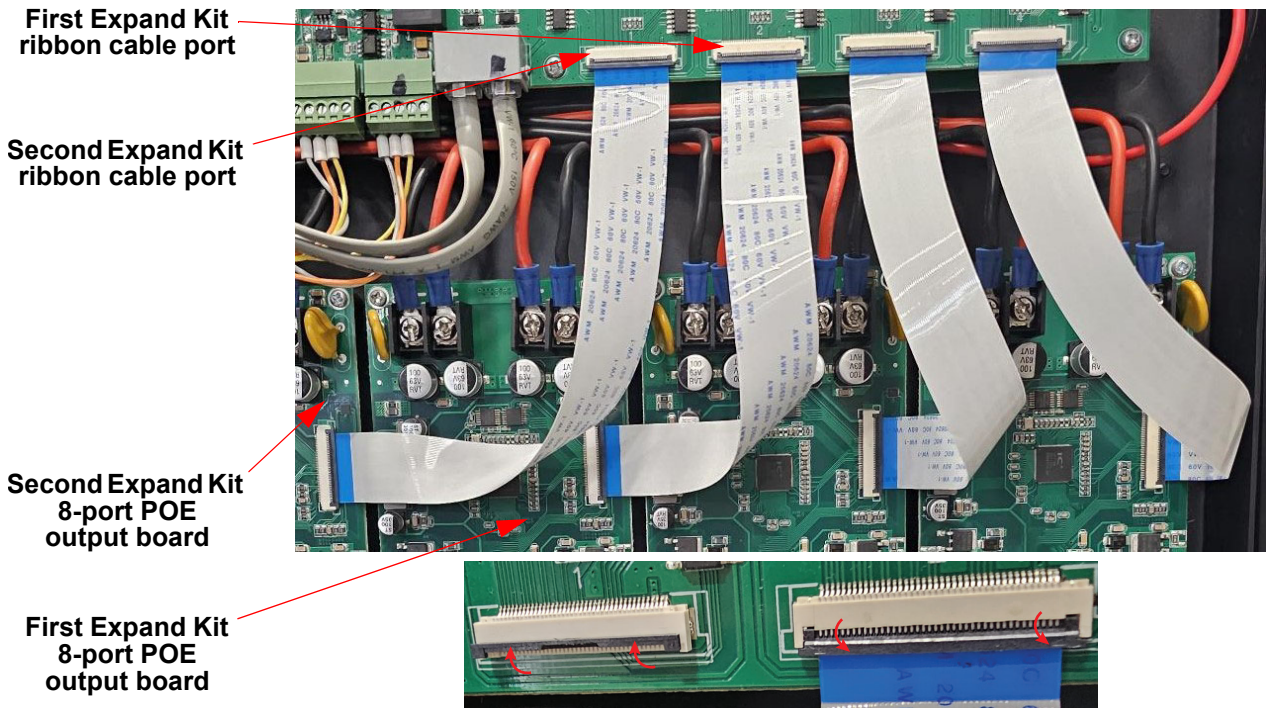

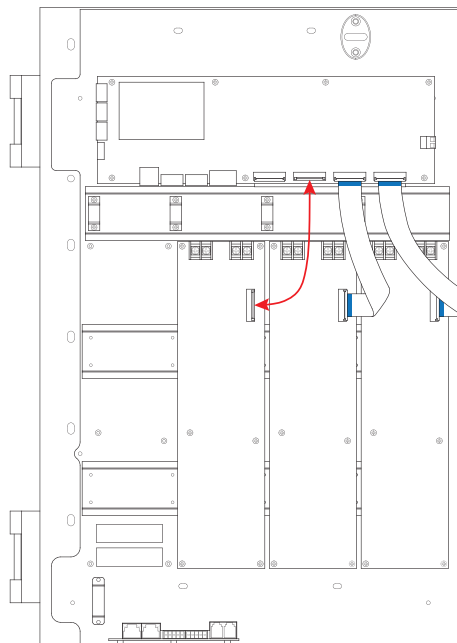

3. Insert the ribbon cable into the corresponding ports in such a way that when viewing the circuit boards with the access panel open the blue tips are visible. Then close the ribbon ports.



Step 5
Power Supply Overview



-  Remove to free wires or remove plastic anchor
-  Loosen to free wire(s)

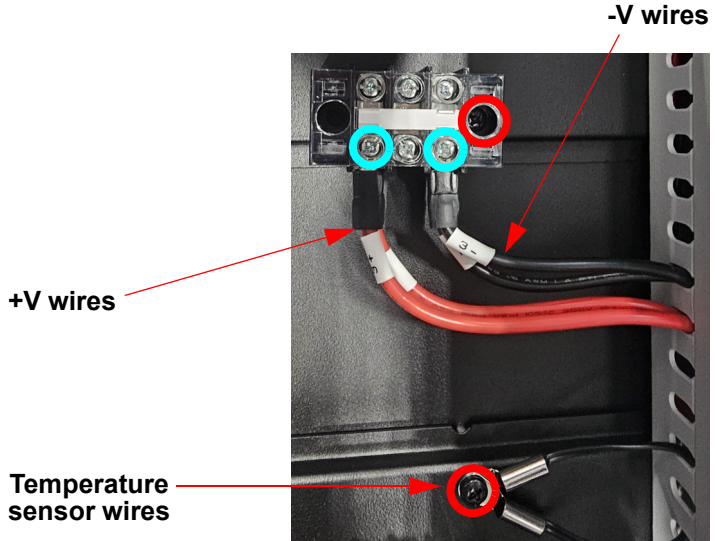
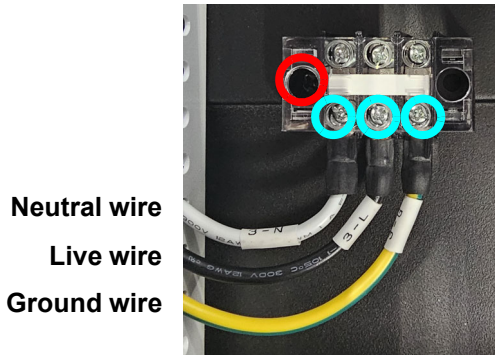

Step 5 Instructions

1. Use a #2 Phillips-head screwdriver to free the 8 indicated wires for the Expand Kit power supply, and remove the 2 plastic anchors that were holding them in place.
2. Use a #2 Phillips-head screwdriver to install the power supply with the 4 screws, installing the temperature sensor wire to the nearest screw hole. Use the pre-installed power supplies as an example, as indicated below.

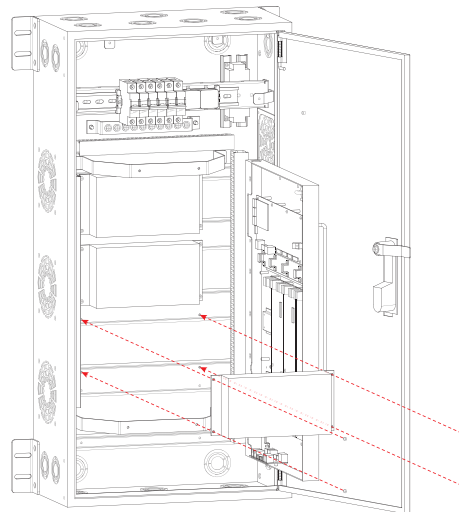
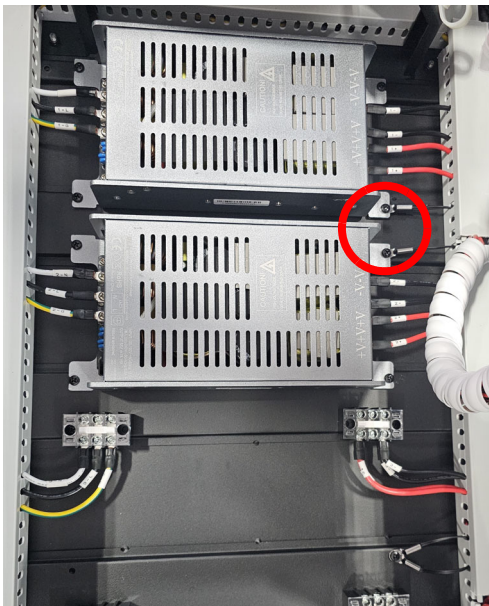

- If only installing 1 Expand Kit, install both temperature sensor wires to the same screw hole until it is necessary to install a second Expand Kit. Do not leave any wires loose or dangling.
If installing a second Expand Kit at a different time than the first, it will be necessary to remove the lower temperature sensor wire from the first Expand Kit power supply to make it possible to install it to the second Expand Kit power supply.

3. Use a #2 Phillips-head screwdriver to install the AC power wires on the left of the power supply.
 - Connect the white (N) wire to the terminal marked “AC/N”.
 - Connect the black (L) wire to the terminal marked “AC/L”.
 - Connect the Yellow/Green (G) wire to the terminal marked “FG”.
4. Use a #2 Phillips-head screwdriver to install the DC output wires on the right of the power supply.
 - Connect the black (-) wires to the top and bottom terminals marked “-V”.
 - Connect the red (+) wires to the top and bottom terminals marked “+V”.

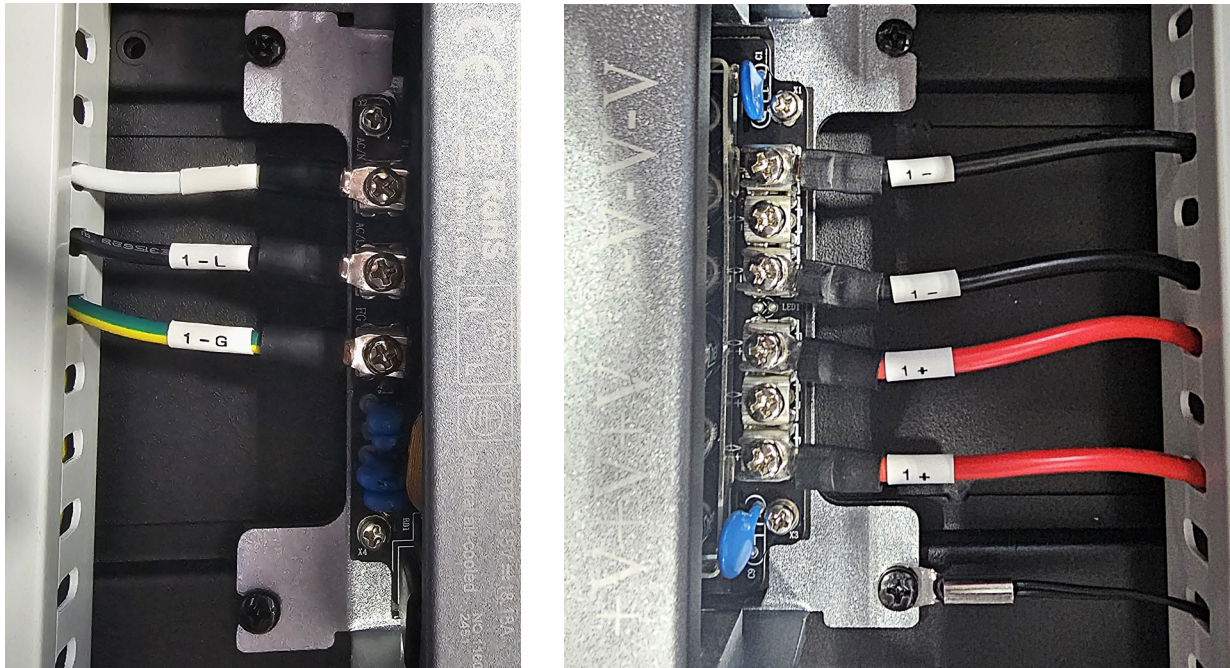

5. Connect the product to power and check the temperature of each screw terminal with a multi-meter to ensure none are overheating. If a screw terminal is overheating, check the quality of the connection and measure again. If the screw terminal is still overheating, contact customer service.
6. Check the applicable **Power _ Temperature** readout under the **Local > Local Info** section of the menu and compare to the **Power 1 Temperature** and **Power 2 Temperature** readouts. If the new power supply shows a - or + temperature:
 - a. Disconnect the product from power.
 - b. Check the quality of each screw terminal connection, as well as the temperature sensor wire connection.
 - c. Reconnect the product to power and check the **Power _ Temperature** readout again.
 - d. If the temperature readings are still abnormal, contact customer service.



If only 1 Expand Kit is installed and both temperature sensor wires are installed as instructed, the Power 2 Temperature readout should be identical to the Power 1 Temperature readout. Ignore this.

7. Disconnect the product from power before continuing to **Step 6**

Step 6

1. Use a #2 Phillips-head screwdriver to loosen the left-most rail clamp and slide it to the left.
2. Clip the Expand Kit DIN rail breaker onto the rail, with the release tab pointed down.
3. Slide the rail clamp back to the right until it is up against the Expand Kit DIN rail breaker and the breakers are all together.
4. Use a #2 Phillips-head screwdriver to tighten the rail clamp.

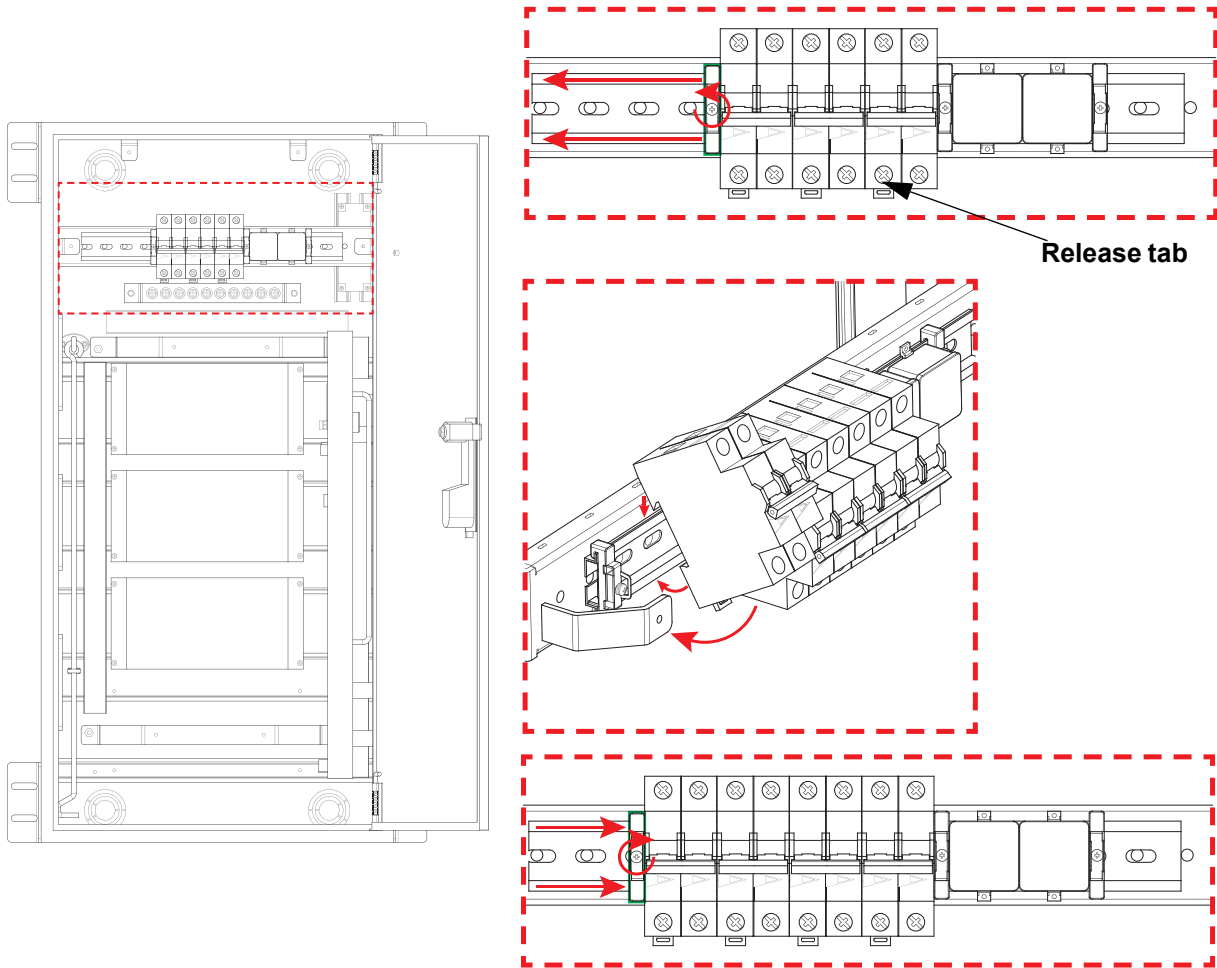

Rail clamps may not be as illustrated, and may feature 1 or 2 screws.

5. Use a #2 screwdriver to:
 - a. Free a set of power input wires from the plastic anchor, and:
 - b. Install them to the top of the Expand Kit DIN rail breaker with the black wire on the right and the white wire on the left.
6. Use a #2 screwdriver to:
 - a. Free the applicable set of power output wires (set 3 for the first Expand Kit DIN rail breaker or set 4 for the second) from the plastic anchor, and:
 - b. Install them to the bottom of the Expand Kit DIN rail breaker with the black wire on the right and the white wire on the left.

**Power input wire set
Install to top of either Expand Kit DIN breaker**

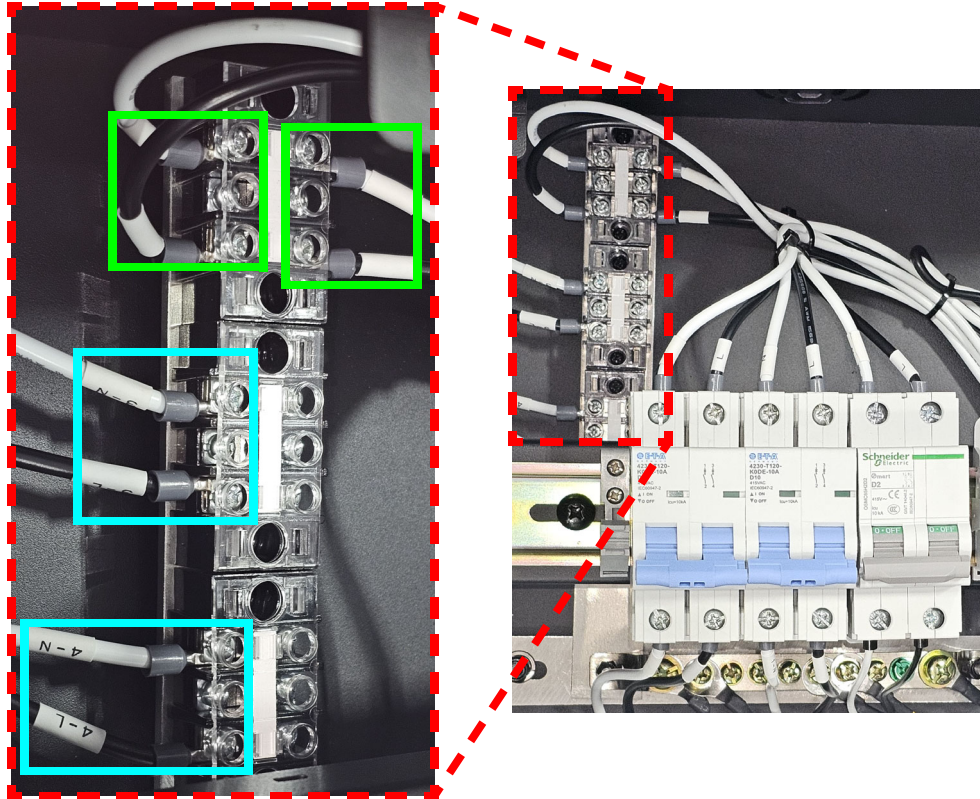

**Power output wire set
Install set 3 to bottom of first Expand Kit DIN breaker
Install set 4 to bottom of second Expand Kit DIN breaker**



- **Do NOT cross the power input wires with the power output wires! Ensure these wires only contact their designated connectors!
Leave unused wires attached to the plastic anchor.**

Step 7

Use zip ties or other fasteners to secure the indicated wire snakes to the indicated openings. This prevents the wires from being caught in between parts when opening or closing the product.

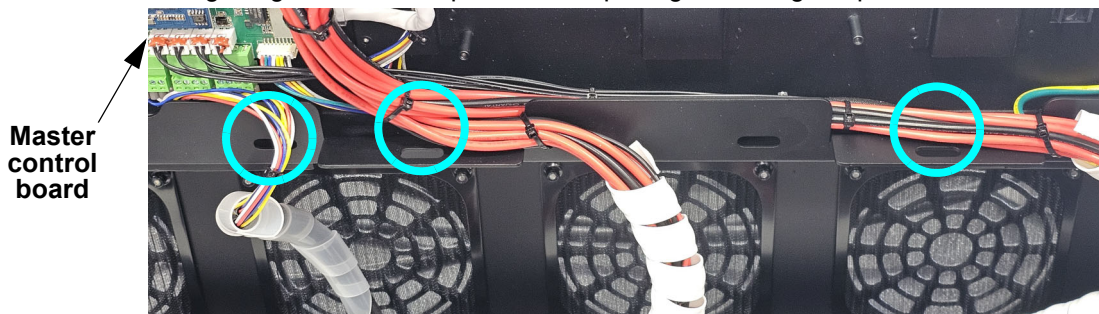

Step 8

1. Carefully fit the breaker cover over the DIN rail breakers and close the service access panel.
2. Use a #2 Phillips-head screwdriver and a 2.5 mm hex wrench to install the previously removed screws.

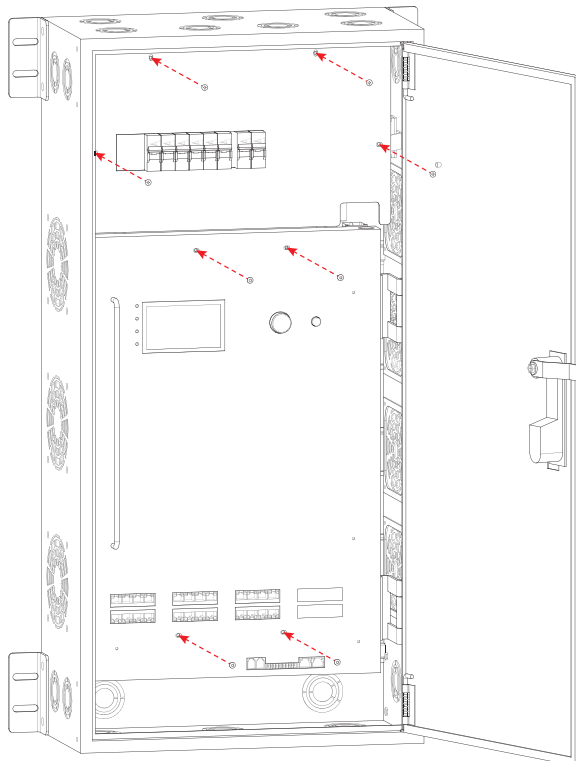
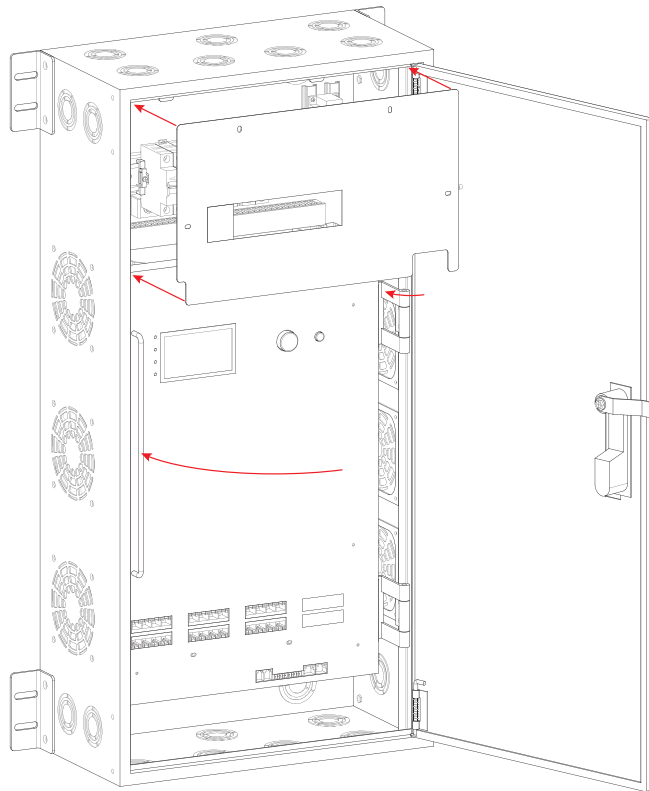

Finished

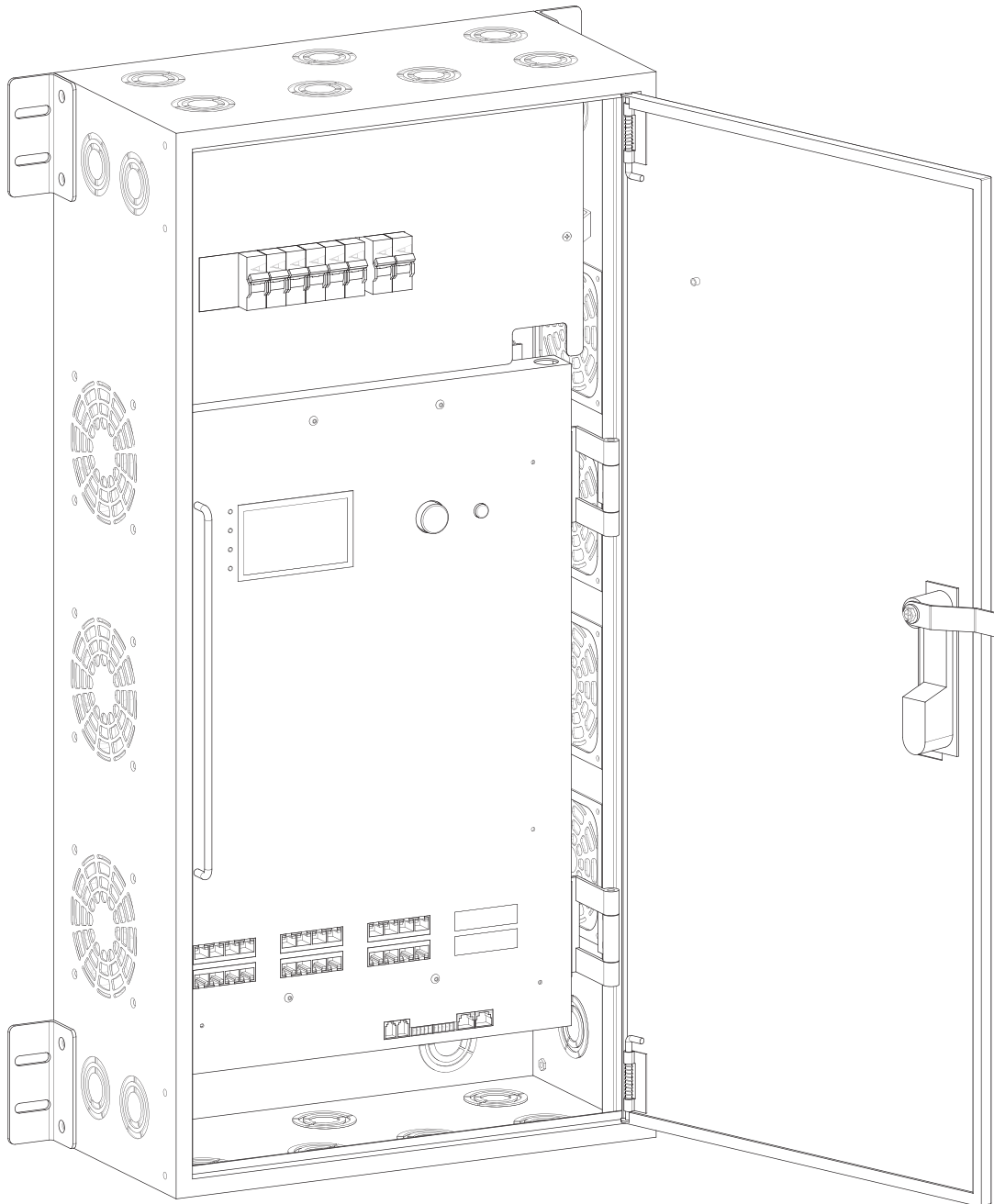

1 LOGIC Wall Panel Expansion Kit8 has been installed in the above image. It is possible to install up to 2 LOGIC Wall Panel Expansion Kit8 products in each LQGIC Wall Panel 16-Port.

4. Operation

Control Panel Description

See the [Product Overview](#) for a detailed description of the control panel.

Programming

Refer to the Menu Map to understand the menu options. The menu map shows the main level and a variable number of programming levels for each option.

- To access the menu from the Home Screen, press the **<MENU>** knob.
- To scroll through the options on each level of the menu, turn the **<MENU>** knob. Turn it clockwise to scroll down, and turn it counter-clockwise to scroll up.
- Press the **<MENU>** knob to select the highlighted option. This will take you to the next programming level for that option, or it will highlight a value that can be edited.
- To increase a selected number value, turn the **<MENU>** knob clockwise. To decrease a selected number value, turn the **<MENU>** knob counter-clockwise.
- Press **<ESC/BACK>** to exit to the previous main level, press repeatedly to return to the Home Screen.

Password

After being prompted to enter the password, use the **<MENU>** knob to select and enter **123456**.

Menu Map

Refer to the LQIC Wall Panel 16- Port product page on www.iluminarc.com for the latest menu maps and software.

Main Level	Programming Levels				Description	
Protocol	DMX512				Selects the control protocol	
	ArtNet					
	sACN					
Local	Output Status	Output 1-32 Status	Status: - - - - -	Shows Normal or Fault		
			Connect: - - -		Shows On or Off	
			CLASS: - - - - -		Shows None or 1-8	
			V1: _ _ V Cur 1: _ _ mA		Shows voltage and current of output	
			V2: _ _ V Cur 2: _ _ mA		Shows power of output	
			Power: _ _ W			
	Net Switch	2.X.X.X			Selects the first value of the IP address	
		10.X.X.X				
	Universe	000-255 / 001-256 (Art-Net™) (sACN)			Selects universe	
	Password	ON			Enables/disables password lock: 123456	
		OFF				
	Priority	Control panel			Wall Con input has priority	
		Signal			Signal input has priority	
	History	List	- - - - -			Displays connected product history
		Clear	No			Cancel clear
Yes			Clear history			
Wall Con Zone	Wall Con Zone One	Group 1-16	Wall Con 1-4	0-31	Sets zone and group of selected Wall Con, or disables it	
				OFF		
	Wall Con Zone Two	Group 1-16	Wall Con 1-4	0-31		
				OFF		

Main Level	Programming Levels		Description
Local (cont.)	Version	V _._._	Shows current firmware version
	IP Address	._._. _._._	Shows the IP address
	Fixture Hours	_ hours	Shows length of time product has been on
		_ _ minutes	
		_ _ seconds	
	Label	LOGIC Wall Panel	Shows device label
	Device UID	._._._._._	Shows device UID
	MAC Address	._._. _._. _._._	Shows the MAC address
	Temperature	_._ °C	Shows the current temperature in °C
	Power 1 Temperature	_._ °C	Shows NTC 1 temperature in °C
	Power 2 Temperature	_._ °C	Shows NTC 2 temperature in °C
	Power 3 Temperature	_._ °C	Shows NTC 3 temperature in °C
	Power 4 Temperature	_._ °C	Shows NTC 4 temperature in °C
	Warning Messages	0. 1=DMX signal lost; 2=Network disconnect; 3= Artnet signal lost; 4= Sacn signal lost; 1. Output 1 Overcurrent 2. Output 2 Overcurrent 3. Output 1-Short Circuit 4. Output 2-Short Circuit 5. POE Device No longer connected (may have failed) 6. POE Device Error-undefined 7. POE Hardware Error-undefined 8. Internal network hardware error 9. DRIVER 2X Overheat 10. POE Device overheat (detail which device when selected)	Shows current error(s), e.g. "DMX Signal Lost" or "Devices No Longer Detected"
System Reset	No	Resets the LOGIC Wall Panel 16- Port to factory default settings	
	Yes		
Match Net	No	Sets fixture segment to driver segment	
	Yes		

Main Level	Programming Levels			Description	
Linked Fixture	Order	1- _		Displays order of connected fixtures	
	Output	1-32		Displays fixture port	
	Model	_ _ _ _ _		Displays fixture name	
	Personality	RED		1-channel: dimmer (red only)	
		GREEN		1-channel: dimmer (green only)	
		BLUE		1-channel: dimmer (blue only)	
		WHITE		1-channel: dimmer	
		TW		2-channel, Tunable White: dimmer, color temperature	
		RGB		3-channel: RGB	
		RGBW		4-channel: RGBW	
		RGBW+D		5-channel: dimmer, RGBW	
	FULL		10-channel: dimmer, RGBW, color macros, strobe, auto programs and speed, dimmer speed		
	DMX Address	001–512		Sets DMX address	
	Universe	0–255		Sets universe	
	Version	v _ . _ _		Displays current version	
	Discover	_ _ _		Search for device	
	Fixture	Network	Net Switch	2 . _ . _ . _ 10 . _ . _ . _	Sets the IP address
		IP Address	2 . _ . _ . _		Shows the linked device IP address
		Device UID	_ _ _ _ _		Shows the linked device UID
		MAC Address	0 _ _ _ _ _		Shows the linked device MAC address
Temperature		_ . _ °C		Displays linked device temperature	
Label		_ _ _		Displays linked device name	
Fixture Hours		_ _ _ hours		Displays working hours of linked device	
Factory Reset		No Yes		Resets linked device	
Static	Red	000–255		Temporary manual control of all connected products. Combine red, green, blue, and white to make a custom color.	
	Green	000–255			
	Blue	000–255			
	White	000–255			
	Strobe	000–255		Sets standalone strobe speed	
Record	Play	Record1–64 _ _ : _ _ : _ _	Record 1–64: Play/pause	Plays back recorded input. Press the <Encoder> knob to toggle play and stop.	
	Record	Record1–64	Record 1–64 Clr	Captures/records live controller input to selected Record slot. Press the <Encoder> knob to start and stop.	

Main Level	Programming Levels			Description	
System Clock	Schedule	Everyday <input type="radio"/> / <input checked="" type="radio"/>	Turn on 00-23:00-59:00-59	Turn off	Schedules daily times to turn on and off (stackable with other schedule options)
		By date <input type="radio"/> / <input checked="" type="radio"/>	Turn on Month:01-12 Day:01-31 Year:2000-99	Turn off Month:01-12 Day:01-31 Year:2000-99	Schedules a date and time to turn on and off (stackable with other schedule options)
		By week <input type="radio"/> / <input checked="" type="radio"/>	Mon :	<input type="radio"/> / <input checked="" type="radio"/>	Schedules which days of the week to be on or off (stackable with other schedule options)
			Tues :	<input type="radio"/> / <input checked="" type="radio"/>	
			Wed :	<input type="radio"/> / <input checked="" type="radio"/>	
			Thur :	<input type="radio"/> / <input checked="" type="radio"/>	
			Fri :	<input type="radio"/> / <input checked="" type="radio"/>	
	Sat :		<input type="radio"/> / <input checked="" type="radio"/>		
	Sun :	<input type="radio"/> / <input checked="" type="radio"/>			
	Setting Clock	SysClock:	24 hours		Shows system clock is 24-hour
		Date:	01-12:01-31:2000-2099		Sets the current date
		Time:	00-23:00-59:00-59		Sets the current time
		Week:	1-7		Sets the current day of the week
	Fade In/Out	Fade In	On-instant		Sets fade in to instant
On-3second fade			Sets fade in to 3-second fade		
Fade Out		Off-instant		Sets fade out to instant	
		Off-3second fade		Sets fade out to 3-second fade	
Enable Clock	No			Enables/disables clock functions	
	Yes				

RDM Chart

Refer to the LQGIC Wall Panel 16- Port product page on www.iluminarc.com for the latest RDM chart.

GET	SET	Category	RDM Parameter IDs (Slot 21-22)	Value	Required	Detail
		Network Management	DISC_UNIQUE_BRANCH	0x0001	✓	
			DISC_MUTE	0x0002	✓	
			DISC_UN_MUTE	0x0003	✓	
✓		RDM Information	QUEUED_MESSAGE	0x0020		
✓			SUPPORTED_PARAMETERS	0x0050	✓	IDENTIFY_DEVICE, DEVICE_INFO, SOFTWARE_VERSION_LABEL, SUPPORTED_PARAMETERS, DMX_START_ADDRESS, DEVICE_MODEL_DESCRIPTION, MANUFACTURER_LABEL, DEVICE_LABEL, DMX_PERSONALITY, PERSONALITY_DESCRIPTION, SENSOR_DEFINITION, SENSOR_VALUE
✓			PARAMETER_DESCRIPTION	0x0051	✓	
✓			DEVICE_INFO	0x0060	✓	1, RDM Protocol Version: V1.0; 2, Device_Mode_ID: 0x21A408B9; 3, Product Category Defines: PRODUCT_CATEGORY_FIXTURE_FIXED; 4, Software Version ID; 5, DMX512 Footprint; 6, DMX512 Personality; 7, DMX512 Start Address; 8, Sensor Count;
		Product Information	PRODUCT_DETAIL_ID_LIST	0x0070		
✓			DEVICE_MODEL_DESCRIPTION	0x0080		LOGIC WALL PANEL
✓			MANUFACTURER_LABEL	0x0081		ILUMINARC
✓	✓		DEVICE_LABEL	0x0082		LOGIC WALL PANEL
✓			SOFTWARE_VERSION_LABEL	0x00C0	✓	V_._
✓	✓		FACTORY_DEFAULTS			FACTORY_DEFAULTS : yes
✓	✓		DMX_PERSONALITY	0x00E0		9pcs persons
✓		DMX Setup	DMX_PERSONALITY_DESCRIPTION	0x00E1		RED/1CH, GREEN/1CH, BLUE/1CH, WHITE/1CH, TW/2CH, RGB/3CH, RGBW/4CH, RGBW+D/5CH, FULL/10CH
✓	✓		DMX_START_ADDRESS	0x00F0	✓	1-503
✓		Sensors	SENSOR_DEFINITION	0x0200		0.) Product Temperature _ _ °C
✓			SENSOR_VALUE	0x0201		—20° —100°
✓	✓	Control	IDENTIFY_DEVICE	0x1000	✓	Identify State: Off

Home Screen

The LQGIC Wall Panel 16- Port has a home screen that shows the current control protocol, number of connected LQGIC products, IP address, and date as set on the internal calendar. The home screen will also indicate if the System Clock has placed the product in **Shut off** mode.

To see the home screen, press **<ESC/BACK>** repeatedly until it shows on the display.

Illuminarc

Control Protocol Logic Wall Panel

1/17/2024
12:08:55

IP: 2.101.0.48
Online:
Status:

Control Protocol

The LQGIC Wall Panel 16- Port works with DMX, Art-Net™, and sACN control signals. To select which protocol to use:

1. Go to the **Protocol** main menu.
2. Select the desired protocol, from **DMX512**, **ArtNet**, or **sACN**.

Local

The Local settings include the network settings for the LQGIC Wall Panel 16- Port as well as system information and other general options.

Output Status

To view the status of the output ports:

1. Go to the **Local** main menu.
2. Select the **Output Status** option.
3. Select the output, from **Output 1 Status** to **Output 32 Status**.
4. View the output data:
 - **Status:** Shows **Normal** or **Fault** (if no connection or faulty connection).
 - **Connect:** Shows **On** (connected) or **Off** (not connected).
 - **CLASS:** Shows **None** or the type of POE connection, from **1–8**.
 - **V1, Cur 1, V2, Cur 2, and Power:** electrical data in volts, milliamperes, and watts.

Net Switch

To select the first value of the IP address for the LQGIC Wall Panel 16- Port:

1. Go to the **Local** main menu.
2. Select the **Net Switch** option.
3. Select the first value of the IP address from **2.X.X.X** or **10.X.X.X**.
 - **The first value of the IP address of each connected LQGIC product MUST match that of the LQGIC Wall Panel 16- Port, or they will not be able to link properly.**
 - **Changing the Net Switch setting may cause the LQGIC Wall Panel 16- Port to disconnect from any connected products.**



Universe

To assign an Art-Net™ or sACN universe to the LQGIC Wall Panel 16- Port:

1. Go to the **Local** main menu.
2. Select the **Universe** option.
3. Set the universe, from **000–255** (for Art-Net™) or from **001–256** (for sACN).

Password Lock

To turn the password lock on or off:

1. Go to the **Local** main menu.
2. Select the **Password** option.
3. Select from **ON** or **OFF**.



When the password lock is activated, the product will prompt for the password in order to access the menu. Use the <MENU> knob to select and enter 123456.

Priority

To select whether input from a LQGIC Wall Controller or input from a control signal (DMX, Art-Net™, or sACN) will take priority over the other:

1. Go to the **Local** main menu.
2. Select the **Priority** option.
3. Select from **Control Panel** or **Signal**. The selected option will have priority.

History

The LQGIC Wall Panel 16- Port keeps a record of all LQGIC products to which it has linked.

To view the history:

1. Go to the **Local** main menu.
2. Select the **History** option.
3. Select the **List** option.

Wall Con Zone

To set the zone and group of a selected Wall Con:

1. Go to the **Local** main menu.
2. Select the **Wall Con Zone** option.
3. Select either the **Wall Con Zone One** option or **Wall Con Zone Two** option.
4. Select a group from **Group 1–16**.
5. Select a **Wall Con** from **Wall Con 1–4**.
6. Select a device from **0–31** or select **OFF** to disable.

Local Information

To view general information including the firmware version, IP address, and any current errors:

1. Go to the **Local** main menu.
2. Select the **Local Info** option.
3. Select which information to view, from:
 - **Version** (current firmware version),
 - **IP Address**,
 - **Fixture Hours** (the amount of time the product has been powered on, in hours, minutes, and seconds),
 - **Label**,
 - **Device UID**,
 - **MAC Address**,
 - **Temperature** (in degrees Celsius),
 - **Power Temperature 1–4** (in degrees Celsius), or
 - **Warning Messages** (current errors)

System Reset

To reset the LQGIC Wall Panel 16- Port to factory default settings:

1. Go to the **Local** main menu.
2. Select the **System Reset** option.
3. Select from **No** or **Yes**.



System Clock settings will not be reset.

Match Net

To set the fixture segment to the driver segment:

1. Go to the **Local** main menu.
2. Select the **Match Net** option.
3. Select the **No** or **Yes** option.

Disconnecting Products from the LQGIC Wall Panel 16- Port

When any linked LQGIC product which has linked to the LQGIC Wall Panel 16- Port is disconnected or removed, it will trigger an error message. To remove the error message, either reconnect the product or clear the history so the LQGIC Wall Panel 16- Port no longer has a record of that product being linked.

To clear the history:

1. Go to the **Local** main menu.
2. Select the **History** option.
3. Select the **Clear** option.
4. Select from **No** (cancel) or **Yes** (clear).

Linked Fixture

Use control configurations to operate the connected LQIG products with a DMX, Art-Net™, or sACN controller.

Linked LQIG Product Menu Map

To access the menu map for a connected LQIG product:

1. Go to the **Linked Fixture** main menu.
2. Select **Status**.
3. Select the output to which the desired LQIG product is connected, from **Output 1-32**.
4. Select the desired LQIG product. The selected product will flash its LEDs for the duration it is being accessed.

Refer to the LQIG Wall Panel 16- Port product page and the product page for the selected LQIG product on www.iluminarc.com for the latest menu maps.

Main Level	Programming Levels		Description
Dmx Address	001–512		Selects DMX address
Personality	RED		1-channel: dimmer (red only)
	GREEN		1-channel: dimmer (green only)
	BLUE		1-channel: dimmer (blue only)
	WHITE		1-channel: dimmer (white only)
	TW		2-channel, Tunable White: dimmer, color temperature
	RGB		3-channel: RGB control
	RGBW		4-channel: RGBW control
	RGBW+D		5-channel: dimmer, RGBW control
Network	Net Switch	2.X.X.X	Selects the first value of the IP address
		10.X.X.X	
	Universe	000–255 / 001–256 (Art-Net™) (sACN)	Selects universe
Information	Version	V _._._	Shows current firmware version
	IP Address	_._._. _._._. _._._. _._._	Shows the IP address
	Fixture Hours	_ hours	Shows length of time product has been on
	Label	_ _ _ _ _ _ _ _ _ _	Shows product label
	Device UID	_ _ _ _ _ _ _ _ _ _	Shows device UID
	MAC Address	_ _ _ _ _ _ _ _ _ _	Shows the MAC address
Factory Reset	No		Resets to factory default settings
	Yes		
Temperature	_ _ _ °C		Shows the current temperature in °C

Individual LQIG Product Configuration

Individual Control Personality

To set the control personality individually for the selected LQIG product:

1. From the menu of the selected LQIG product, select the **Personality** option.
2. Select the desired personality, from **RED, GREEN, BLUE, WHITE, TW, RGB, RGBW, RGBW+D, or FULL**.



- See the [Starting Address](#) section for the highest starting address you can select for each personality.
- Make sure that the starting addresses on the various products do not overlap due to the new personality setting.

Starting Address

Each product will respond to a unique starting address from the controller. All products with the same starting address will respond in unison. To set the starting address for the selected LQIG product:

1. From the menu of the selected LQIG product, select the **DMX Address** option.
2. Select the starting address (**001–512**).

Personality	Channels	Highest Address	Products per Universe
RED	1	512	512
GREEN	1	512	512
BLUE	1	512	512
WHITE	1	512	512
TW	2	511	256
RGB	3	510	170
RGBW	4	509	128
RGBW+D	5	508	102
FULL	10	503	51

Network Settings

The Network Settings control the first value of the IP address and the universe of the selected LQIG product.

Net Switch

To select the first value of the IP address for the selected LQIG product:

1. From the menu of the selected LQIG product, select the **Network** option.
2. Select the **Net Switch** option.
3. Select the first value of the IP address from **2.X.X.X** or **10.X.X.X**.



- **The first value of the IP address of each connected LQIG product MUST match that of the LQIG Wall Panel 16- Port, or they will not be able to link properly.**
- **Changing the Net Switch setting may cause the selected product to disconnect from the LQIG Wall Panel 16- Port.**

Universe

To assign an Art-Net™ or sACN universe to the selected LQIG product:

1. From the menu of the selected LQIG product, select the **Network** option.
2. Select the **Universe** option.
3. Set the universe, from **000–255** (for Art-Net™) or from **001–256** (for sACN).

Factory Reset

To reset the selected LQIG product to factory default settings:

1. From the menu of the selected LQIG product, select the **Factory Reset** option.
2. Select **Yes** to reset, or **No** to cancel.

Information

To view additional information on the status of the selected LQIG product:

1. From the menu of the selected LQIG product, select the **Information** option.
2. Select which information to view, from **Version, IP Address, Fixture Hours, Label, Device UID, MAC Address, and Temperature**.

Renew

To re-scan for connected LQGIC products:

1. Go to the **Linked Fixture** main menu.
2. Select **Status**.
3. Select **Renew**.
4. Select from **No** (cancel) or **Yes** (renew).

Control Personality (Global)

To set the control personality of all connected LQGIC products at once:

1. Go to the **Linked Fixture** main menu.
2. Select the **Personality** option.
3. Select the desired personality, from **RED, GREEN, BLUE, WHITE, TW, RGB, RGBW, RGBW+D,** or **FULL**.



- See the [Starting Address](#) section for the highest starting address you can select for each personality.
- Make sure that the starting addresses on the various products do not overlap due to the new personality setting.

Power Selection

To set the maximum output level for all connected LQGIC products:

1. Go to the **Linked Fixture** main menu.
2. Select **Power Selection**.
3. Select from **Power 100%, Power 50%,** or **Power 30%**.

Breaking Signal

To set how the LQGIC Wall Panel 16- Port will respond to losing the control signal:

1. Go to the **Linked Fixture** main menu.
2. Select **Breaking Signal**.
3. Select from:
 - **Current State** (holds the current value),
 - **Blackout** (blacks out all connected LQGIC products),
 - or
 - **White** (sets all connected LQGIC products to full output).

Control Channel Assignments and Values

FULL (10 Channels)

Channel	Function	Value	Percent/Setting
1	Dimmer	000 ⇄ 255	0–100%
2	Red	000 ⇄ 255	0–100%
3	Green	000 ⇄ 255	0–100%
4	Blue	000 ⇄ 255	0–100%
5	White	000 ⇄ 255	0–100%
6	Color temperature	000 ⇄ 010	No function
		011 ⇄ 020	1800K
		021 ⇄ 030	2200K
		031 ⇄ 040	2700K
		041 ⇄ 050	3000K
		051 ⇄ 060	3200K
		061 ⇄ 070	4000K
		071 ⇄ 080	4500K
		081 ⇄ 090	5000K
		091 ⇄ 100	5600K
		101 ⇄ 110	6000K
		111 ⇄ 120	6500K
		121 ⇄ 130	7000K
		131 ⇄ 140	8000K
141 ⇄ 150	10000K		
151 ⇄ 255	No function		
7	Strobe	000 ⇄ 009	No function
		010 ⇄ 099	Strobe, 0–25 Hz
		100 ⇄ 109	No function
		110 ⇄ 179	Lightning strobe, slow to fast
		180 ⇄ 189	No function
		190 ⇄ 255	Random strobe, slow to fast
8	Auto programs	000 ⇄ 040	No function
		041 ⇄ 050	Automatic program 1
		051 ⇄ 060	Automatic program 2
		061 ⇄ 070	Automatic program 3
		071 ⇄ 080	Automatic program 4
		081 ⇄ 090	Automatic program 5
		091 ⇄ 100	Automatic program 6
		101 ⇄ 110	Automatic program 7
		111 ⇄ 120	Automatic program 8
		121 ⇄ 130	Automatic program 9
		131 ⇄ 140	Automatic program 10
141 ⇄ 255	No function		
9	Auto program speed	000 ⇄ 255	Automatic program speed, slow to fast
10	Dimmer speed	000 ⇄ 129	Dimmer curve on
		130 ⇄ 255	Dimmer curve off

RGBW+D (5 Channels)

Channel	Function	Value	Percent/Setting
1	Dimmer	000 ⇔ 255	0–100%
2	Red	000 ⇔ 255	0–100%
3	Green	000 ⇔ 255	0–100%
4	Blue	000 ⇔ 255	0–100%
5	White	000 ⇔ 255	0–100%

RGBW (4 Channels)

Channel	Function	Value	Percent/Setting
1	Red	000 ⇔ 255	0–100%
2	Green	000 ⇔ 255	0–100%
3	Blue	000 ⇔ 255	0–100%
4	White	000 ⇔ 255	0–100%

RGB (3 Channels)

Channel	Function	Value	Percent/Setting
1	Red	000 ⇔ 255	0–100%
2	Green	000 ⇔ 255	0–100%
3	Blue	000 ⇔ 255	0–100%

TW (Tunable White: 2 Channels)

Channel	Function	Value	Percent/Setting
1	Dimmer	000 ⇔ 255	0–100%
2	Color temperature	000 ⇔ 010	No function
		011 ⇔ 020	1800K
		021 ⇔ 030	2200K
		031 ⇔ 040	2700K
		041 ⇔ 050	3000K
		051 ⇔ 060	3200K
		061 ⇔ 070	4000K
		071 ⇔ 080	4500K
		081 ⇔ 090	5000K
		091 ⇔ 100	5600K
		101 ⇔ 110	6000K
		111 ⇔ 120	6500K
		121 ⇔ 130	7000K
		131 ⇔ 140	8000K
		141 ⇔ 150	10000K
		151 ⇔ 255	No function

WHITE (1 Channel)

Channel	Function	Value	Percent/Setting
1	Dimmer	000 ⇔ 255	White only, 0–100%

BLUE (1 Channel)

Channel	Function	Value	Percent/Setting
1	Dimmer	000 ⇔ 255	Blue only, 0–100%

GREEN (1 Channel)

Channel	Function	Value	Percent/Setting
1	Dimmer	000 ⇔ 255	Green only, 0–100%

RED (1 Channel)

Channel	Function	Value	Percent/Setting
1	Dimmer	000 ⇔ 255	Red only, 0–100%

Static

To take temporary manual control of all connected LQIC products, custom mix a color, and assign a strobe speed:

1. Go to the **Static** main menu.
2. Select which value to alter, from **Red, Green, Blue, White, or Strobe**.
3. Set the selected value, from **000–255**.

For **Strobe**, reference the following table:

Value	Percent/Setting
000 ⇔ 009	No function
010 ⇔ 099	Strobe, 0–25 Hz
100 ⇔ 109	No function
110 ⇔ 179	Lightning strobe, slow to fast
180 ⇔ 189	No function
190 ⇔ 255	Random strobe, slow to fast

4. Press the **<MENU>** knob to cycle to the next value.
5. Repeat steps 3-4 until the products output as desired.
6. Press **<ESC/BACK>** to finish.

Record

The LQGIC Wall Panel 16- Port can record control signal input (DMX, Art-Net™, or sACN) for later playback through the display menu or by a connected LQGIC Wall Controller.

The LQGIC Wall Panel 16- Port has 64 recording slots. When a scene is triggered for playback, it will play continuously until it is stopped or another recording is triggered.



Due to memory capacity it is only recommended to record several seconds of a single look to each recording slot.

Recording

To record a scene:

1. Go to the **Record** main menu.
2. Select the **Record** option.
3. Select the desired recording slot, from **Record1–64**.
4.  will show on the display. Press the **<MENU>** knob to begin recording the current control signal input.





To prevent errors during the recording of a scene, do not change any control signal values.

5.  will show on the display. Press the **<MENU>** knob to stop recording.

Display Menu Playback

To play back a recorded scene via the display menu:

1. Go to the **Record** main menu.
2. Select the **Play** option.
3. Select the desired recording slot, from **Record1–64**.
4.  will show on the display. Press the **<MENU>** knob to begin playback.
5.  will show on the display. Press the **<MENU>** knob to stop playback. The connected products will black out.



- **Pressing the **<MENU>** knob again at this point will restart the recording.**
- **If no scene is recorded to a recording slot, it cannot be selected for playback.**

6. Press **<ESC/BACK>** to exit.

Scene Brightness (via Display Menu)

To set the **Brightness** of the connected LQGIC products from **000–255** during playback of a scene, turn the **<MENU>** knob clockwise or counterclockwise.

LQGIC Wall Controller Playback

To play back a recorded scene via a connected LQGIC Wall Controller:

1. Press the numbered button which corresponds with the number of the desired recording slot to begin playback.
2. Press that same button again to stop playback. The connected products will black out.



- **Pressing the same button again (without holding) at this point will restart the recording.**
- **If no scene is recorded to a recording slot, pressing the corresponding button will do nothing.**

Scene Brightness (via LQGIC Wall Controller)

To increase or decrease the brightness of the connected LQGIC products during playback of a scene, press the **<+>** or **<->** buttons on the LQGIC Wall Controller.

Scene Lock

To lock a scene in place and prevent tampering:

1. Trigger a scene via the LQGIC Wall Controller. A scene cannot be locked if no scene is playing back.
2. Press and hold the same button for 6-10 seconds. The backlight will flash to indicate the scene is locked.
3. Press and hold the button again to release the lock.

Erase Recording

To erase a recording slot:

1. Go to the **Record** main menu.
2. Select the **Record Erase** option.
3. Select the desired recording slot, from **Record1–8 Clr**.
4. Select from **No** (cancel) or **Yes** (erase the selected recording slot).

System Clock

The system clock functions allow the LQGIC Wall Panel 16- Port to place itself in or out of **Shut off** mode on a set schedule. While in **Shut off** mode:

- The LQGIC Wall Panel 16- Port will black out all connected LQGIC products.
- The LQGIC Wall Panel 16- Port will function at minimum power consumption.
- All settings other than the **System Clock** settings will be inaccessible.

Setting Clock

Before setting the schedule, ensure the internal clock and calendar is set correctly:

1. Go to the **System Clock** main menu.
2. Select the **Setting Clock** option.
3. Review the current settings. If they are inaccurate, press the **<MENU>** knob to begin setting the clock. After setting each option, press the **<MENU>** knob to move to the next option.
4. Set the month of the current date, from **01–12** (January to December).
5. Set the day of the month, from **01–31**.
6. Set the year, from **2000–2099**.
7. Set the hour of the day, from **00–23** (in a 24-hour clock, **00** is midnight and **13** is 1 PM).
8. Set the minute of the hour, from **00–59**.
9. Set the second of the minute, from **00–59**.
10. Set the day of the week, from **1–7** (Monday to Sunday).
11. Press **<ESC/BACK>** to exit.

Schedule

The LQGIC Wall Panel 16- Port can be scheduled by the time of day (**Everyday**), from one date to another (**By date**), and by the day of the week (**By week**) all at the same time.



- Selecting the **Everyday**, **By date**, or **By week** options not only enters the sub-menu for the selected option but also automatically enables it.
- To disable the option, select it again from the **Schedule** menu.
- To alter one of these settings, it must be disabled and then reselected.

Everyday

To set the daily schedule:

1. Go to the **System Clock** main menu.
2. Select the **Schedule** option.
3. Select the **Everyday** option.
4. Review the current settings. To begin editing them, press the **<MENU>** knob. After setting each option, press the **<MENU>** knob to move to the next option.
5. Set the **Turn on** hour, from **00–23** (in a 24-hour clock, **00** is midnight and **13** is 1 PM).
6. Set the **Turn on** minute, from **00–59**.
7. Set the **Turn on** second, from **00–59**.
8. Set the **Turn off** hour, from **00–23**.
9. Set the **Turn off** minute, from **00–59**.
10. Set the **Turn off** second, from **00–59**.
11. Select **Enable** to turn on.
12. Press **<ESC/BACK>** to exit.

By date

To set specific dates to turn on and off:

1. Go to the **System Clock** main menu.
2. Select the **Schedule** option.
3. Select the **By date** option.
4. Review the current settings. To begin editing them, press the **<MENU>** knob. After setting each option, press the **<MENU>** knob to move to the next option.
5. Set the **Turn on Month**, from **01–12** (January to December).
6. Set the **Turn on Day**, from **01–31**.
7. Set the **Turn on Year**, from **2000–2099**.
8. Set the **Turn off Month**, from **01–12**.
9. Set the **Turn off Day**, from **01–31**.
10. Set the **Turn off Year**, from **2000–2099**.
11. Press **<ESC/BACK>** to exit.

By week

To set which days of the week to turn on:

1. Go to the **System Clock** main menu.
2. Select the **Schedule** option.
3. Select the **By week** option.
4. Review the current settings. To begin editing them, press the **<MENU>** knob.
5. Select each desired day, from **Sun, Mon, Tues, Wed, Thur, Fri, and/or Sat**.
6. Select any selected day again to deselect it.
7. Press **<ESC/BACK>** to finish, and then again to exit.

Enable Clock

To enable or disable the system clock functions:

1. Go to the **System Clock** main menu.
2. Select the **Enable Clock** option.
3. Select from **No** (disable) or **Yes** (enable).

Fade In and Fade Out

To set whether the lights will turn on or off instantly when entering or leaving **Shut off** mode, or whether they will fade in or out:

1. Go to the **System Clock** main menu.
2. Select which option to set, from **Fade In** or **Fade Out**.
3. For **Fade In**, select from **OFF** or **ON**.
4. For **Fade Out**, select from **OFF** or **ON**.

Web Server

The LQGIC Wall Panel 16- Port web server can be accessed by any computer on the same network as the product. It allows network access to system information, settings such as product addressing, static color testing, and calendar triggers, as well as firmware updates for both the LQGIC Wall Panel 16- Port and any connected LQGIC products.

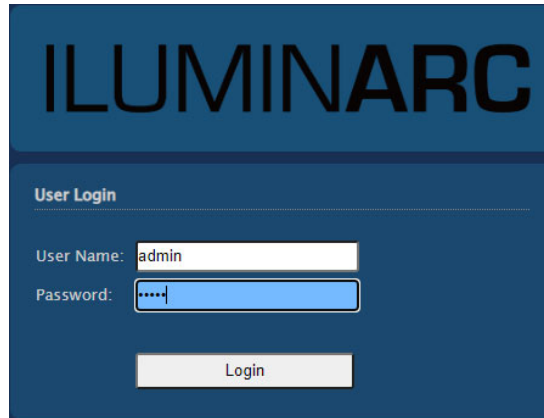

1. Connect the product to a Windows computer with a network cable.
2. On the computer, set the IP address of the new network to have the same value as the [Net Switch](#) setting (**002** or **010**).
3. Enter the IP address of the product into the URL bar of a web browser on the computer.
4. Enter both the User Name and Password as **admin** to log in.

Home

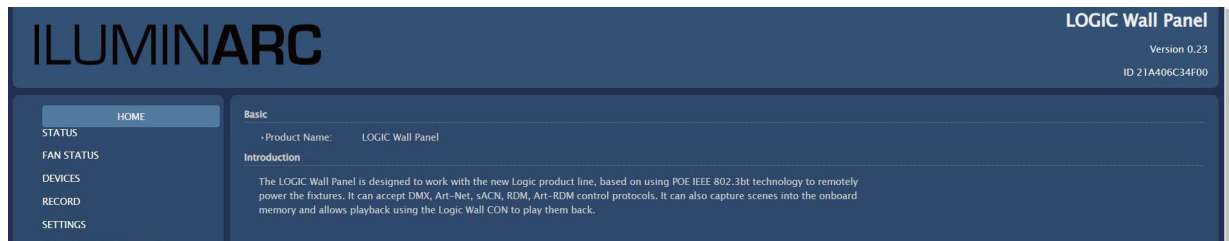

The **HOME** screen displays the name of the product and a brief introduction to it.

Status

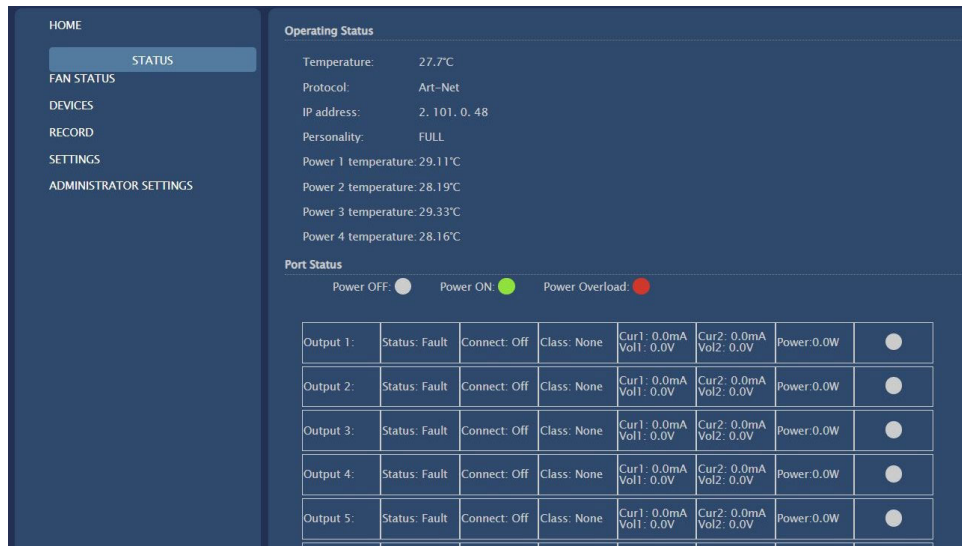

The **STATUS** screen displays the information available in the [Local Information](#) and [Output Status](#) sections of the display menu.

Fixture List

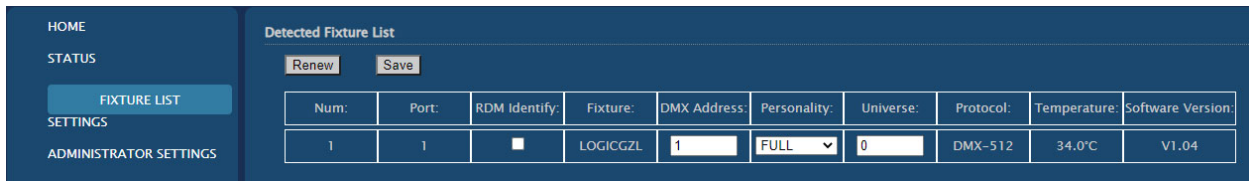

The **FIXTURE LIST** screen displays information for each connected LQIC product which has been detected by the LQIC Wall Panel 16- Port and provides the following control options:

- **Renew:** rescans for connected LQIC products.
- **Save:** sends any changes to the connected LQIC products.
- **RDM Identify:** causes the selected product to blink its LEDs for identification.
- **DMX Address:** displays and sets the DMX Address of the selected product.
- **Personality:** displays and sets the control personality of the selected product.
- **Universe:** displays and sets the universe address of the selected product.



After changing the DMX Address, Personality, or Universe, click Save to send those settings to the selected product(s).

Settings

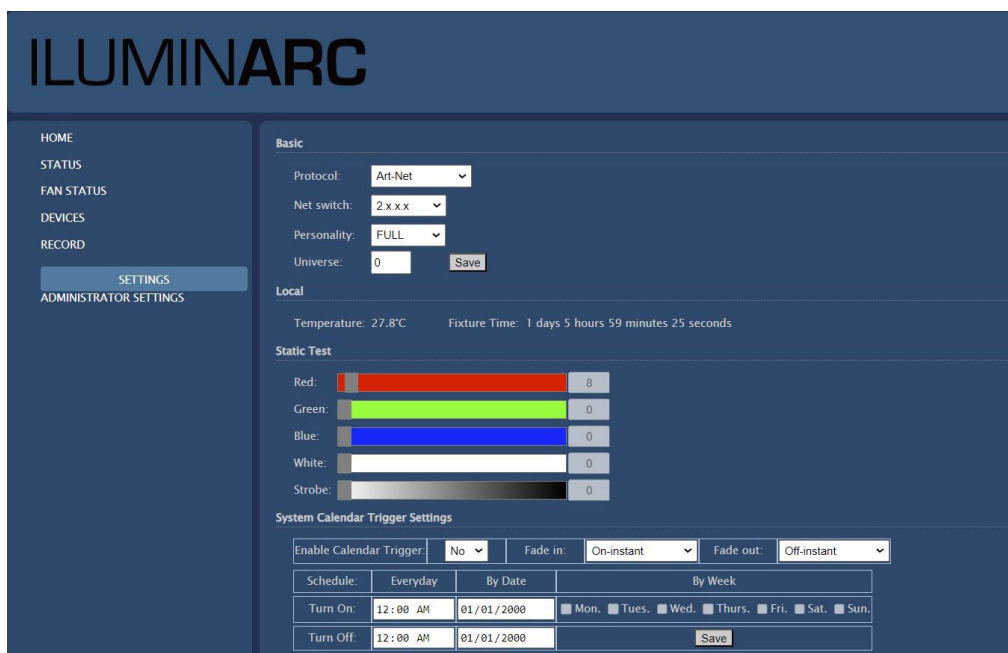

The **SETTINGS** screen displays and provides 5 types of control options:

- **Basic:** displays and sets the control **Protocol**, the first value of the IP address (**Net switch**) for the LQGIC Wall Panel 16- Port, the control **Personality**, and the **Universe** address if applicable. Click **Save** to send any changed settings to the LQGIC Wall Panel 16- Port.



Changing the Net switch option will cause the computer to disconnect from the LQGIC Wall Panel 16- Port.

- **Local:** displays the product **Temperature** in °C and the **Fixture Time**.
- **Static Test:** displays and provides the same control options as the **Static** section of the display menu.
- **System Calendar Trigger Settings:** displays and provides the same control options as the **System Clock** section of the display menu. Click **Save** to send any changed settings to the LQGIC Wall Panel 16- Port.



Years beyond those available through the display menu may be selected through this method, but selecting them may cause unforeseen errors.

- **Reset:** provides the **System Restart** function. Set the drop-down menu to **Yes** and click **Save** to reset the LQGIC Wall Panel 16- Port to factory default settings.

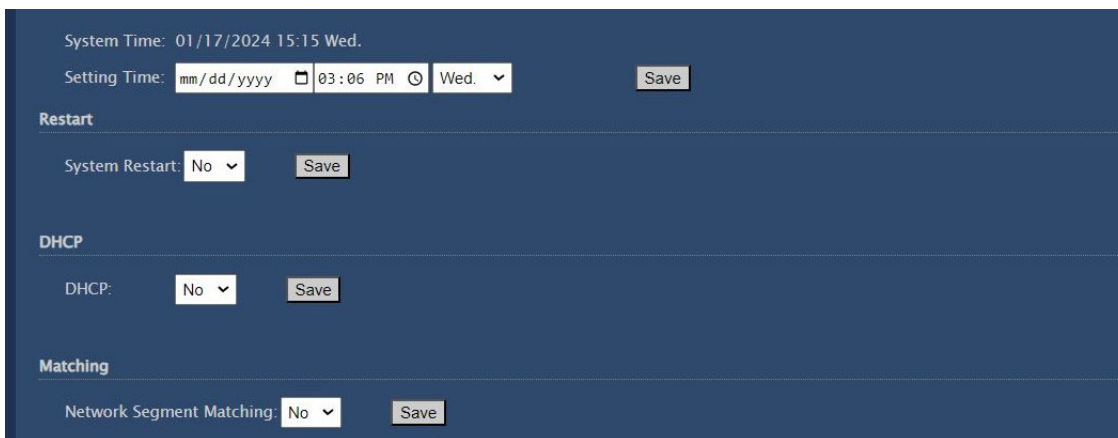

System Clock settings will not be reset.

Administrator Settings

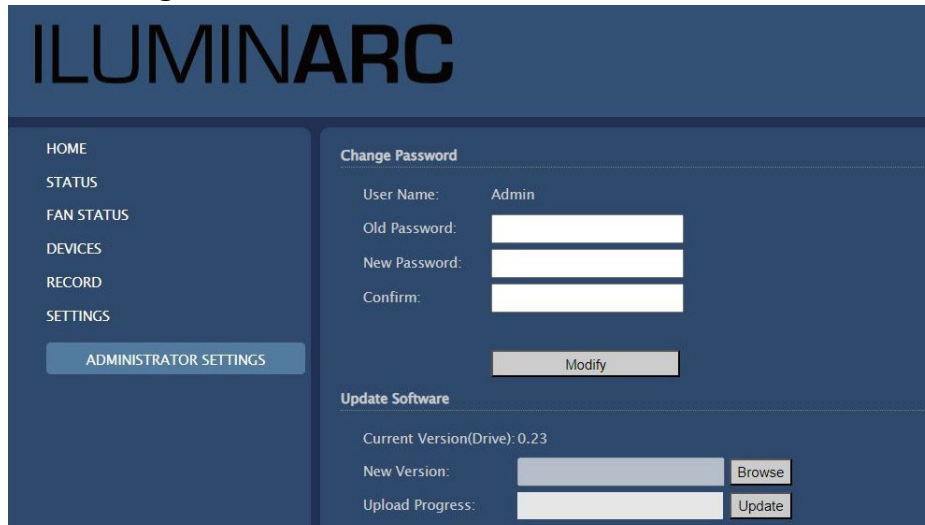

The **ADMINISTRATOR SETTINGS** screen displays the current firmware version of the LQGIC Wall Panel 16- Port and provides the ability to change the web server password, update the firmware of the LQGIC Wall Panel 16- Port, and update the firmware of any connected LQGIC products.

Firmware Update

The procedure for updating the firmware of the LQGIC Wall Panel 16- Port is identical to the procedure for updating the firmware of connected LQGIC products.

1. Download the latest firmware files from www.iluminarc.com.
2. Access the web server for LQGIC Wall Panel 16- Port according to the instructions under [Web Server](#).
3. Navigate to the **ADMINISTRATOR SETTINGS** screen.
4. Click **Browse** and select the desired firmware file.
5. Click **Update**.
 - At this point the web server may return to the login screen. Enter the password to continue, and then redo steps 4 and 5.
 - The Upload Progress bar will fill, indicating the firmware is being sent to the relevant product(s).
 - Data in the firmware files includes a model type signature which allows only the relevant products to receive it.



ALL connected products of the type designated by the firmware file will be updated! Disconnect any products of that type which should not be updated prior to beginning the update procedure!



Connected products which are not of the type designated by the firmware file will not be affected.

- POE injectors will not filter the firmware file transfer.
- During the update the LQGIC Wall Panel 16- Port display menu will freeze and all control signals will be interrupted.
- When updating the LQGIC Wall Panel 16- Port, the message **Remove code 1 MCU erasure** will show on the display, followed by **Updating...** When finished, the LQGIC Wall Panel 16- Port will restart.
- When updating connected LQGIC products, the message **Updata slave Device** will show on the display. When finished, the LQGIC Wall Panel 16- Port will rescan for connected products.

5. Maintenance

Product Maintenance

Dust build-up reduces light output performance and can cause overheating. This can lead to reduction of the light source's life and/or mechanical wear. To maintain optimum performance and minimize wear, clean all lighting products at least twice a month. However, be aware that usage and environmental conditions could be contributing factors to increase the cleaning frequency.

To clean the product, follow the instructions below:

1. Unplug the product from power.
2. Wait until the product is at room temperature.
3. Use a vacuum (or dry compressed air) and a soft brush to remove dust collected on the external surface/vents.
4. Apply a solution of ammonia-free glass cleaner or isopropyl alcohol directly to a soft, lint free cotton cloth or a lens cleaning tissue.
5. Use the cloth or tissue to clean all transparent surfaces.
6. Softly drag any dirt or grime to the outside of the transparent surface.
7. Gently polish the transparent surfaces until they are free of haze and lint.



Always dry the transparent surfaces carefully after cleaning them.

6. Technical Specifications

Dimensions and Weight

Length	Width	Height	Weight
10.31 in (479 mm)	18.86 in (245 mm)	1.73 in (44 mm)	75 lb (34 kg)

Note: Dimensions in inches are rounded.

Power

Power Supply Type	Range	Voltage Selection
Switching (internal)	200 to 240 VAC, 50/60 Hz	Auto-ranging

Output Port Power Rating	Output Port Voltage	POE Output Connectors
92.5 W per port	55.6 VDC	RJ45 x16

Parameter	208 V, 60 Hz	230 V, 50 Hz	240 V, 50 Hz
Consumption	4000 W	4000 W	4000 W
Operating Current	19.23 A	17.39 A	16.66 A

Power I/O	U.S./Worldwide	UK/Europe
Power Input Connectors	Seetronic TRUE1	Seetronic TRUE1
Power Cord plug	Edison (U.S.)	Local Plug
Recommended Power Cable	3 x 10 AWG	

Data Connectors

DMX/RDM	Ethernet (Art-Net™/sACN)	LQIC Wall Controller
5-pin Phoenix in and out	RJ45 x16 (expandable up to 32)	RJ12

POE Cabling

Required Cable Type	Minimum Conductor Diameter	Conductor Material
CAT6/A, shielded	≥23 AWG (≥0.5733 mm)	Solid bare copper wire (stranded not supported)

Cable Plug	Cable Terminator	Recommended Cable (or equivalent)
RJ45, CAT6/A, Shielded	T568B standard	Belden 2413F, 2412F

Total Max Cable Length (Drive to first fixture)	Total Max Cable Length (Drive to last fixture)	Total Max Cable Length (First fixture to last fixture)
≤328 ft (≤100 m)	≤460 ft (≤140 m)	≤131 ft (≤40 m)

Thermal

Operating Temperature Range	Maximum Surface Temperature	Cooling System
-4 °F–113 °F (-20 °C–45 °C)	158 °F (70 °C)	Fan-assisted convection

Ordering

Product Name	Item Name	Item Code	UPC Number
LQIC Wall Panel 16- Port	LOGICWALLPANEL16PORT	01542233	781462225810



UL 2108, UL 1598A
CSA C22.2 No. 250.2
E115166



RoHS



Contact Us

General Information	Technical Support
Chauvet World Headquarters	
Address: 3360 Davie Rd., Suite 509 Davie, FL 33314 Voice: (954) 577-4455 Fax: (954) 929-5560 Toll Free: (800) 762-1084	Voice: (844) 393-7575 Fax: (954) 756-8015 Email: chauvetcs@chauvetlighting.com Website: www.chauvetprofessional.com
Chauvet U.K.	
Address: Pod 1 EVO Park Little Oak Drive, Sherwood Park Nottinghamshire, NG15 0EB UK Voice: +44 (0) 1773 511115 Fax: +44 (0) 1773 511110	Email: UKtech@chauvetlighting.eu Website: www.chauvetprofessional.eu
Chauvet Benelux	
Address: Vaartlaan 9 9800 Deinze Belgium Voice: +32 9 388 93 97	Email: BNLtech@chauvetlighting.eu Website: www.chauvetprofessional.eu
Chauvet France	
Address: 3, Rue Ampère 91380 Chilly-Mazarin France Voice: +33 1 78 85 33 59	Email: FRtech@chauvetlighting.fr Website: www.chauvetprofessional.eu
Chauvet Germany	
Address: Bruno-Bürgel-Str. 11 28759 Bremen Germany Voice: +49 421 62 60 20	Email: DEtech@chauvetlighting.de Website: www.chauvetprofessional.eu
Chauvet Mexico	
Address: Av. de las Partidas 34 - 3B (Entrance by Calle 2) Zona Industrial Lerma Lerma, Edo. de México, CP 52000 Voice: +52 (728) 690-2010	Email: servicio@chauvet.com.mx Website: www.chauvetprofessional.mx

Warranty & Returns

For warranty terms and conditions and return information, please visit our website.

For customers in the United States and Mexico: www.chauvetlighting.com/warranty-registration.

For customers in the United Kingdom, Republic of Ireland, Belgium, the Netherlands, Luxembourg, France, and Germany: www.chauvetlighting.eu/warranty-registration.